

WALCO

**KRONOS
VELA
ALFA PLUS
DERA PLUS**

V.01

Direzionali – Collection

KRONOS
VELA
ALFA PLUS
DERA PLUS

WALCO
OFFICE FURNITURE

Business Classy

Personalità e carattere.

Sono questi i tratti che distinguono le soluzioni Direzionali Walco.

Funzionalità e organizzazione degli arredi office, qui si distinguono per la ricerca del dettaglio, la personalizzazione e le finiture di pregio portate ai massimi livelli. Nascono così ambienti esclusivi dove, grazie alla modularità e alla combinazione di una ampia gamma di materiali e finiture top di gamma, è possibile esprimere il proprio stile.

Personality and character.

These are the qualities that distinguish Walco's Executive solutions.

Functionality and organisation of office furniture are distinguish by the research for detail, the tailor-made design and the high-quality finishes taken to the highest level. This gives life to exclusive living spaces where, thanks to modularity and the combination of a wide range of materials and top finishes, it is possible to express one's own style.

Personnalité et caractère.

Voici les caractéristiques qui distinguent les solutions directionnelles de Walco.

La fonctionnalité et l'organisation de l'ameublement de bureau se distinguent par la recherche du détail, la personnalisation et les finitions de haut de gamme. On crée ainsi des environnements exclusifs où, grâce à la modularité et à la combinaison d'une vaste gamme de matériaux et de finitions de haute qualité, il est possible d'exprimer son propre style.

Index – Collection



Walco 6

KRONOS

Ambiente 01 18
Ambiente 02 38
Ambiente 03 56

VELA

Ambiente 01 74
Ambiente 02 90
Ambiente 03 104

ALFA PLUS

Ambiente 01 120
Ambiente 02 134

DERA PLUS

Ambiente 01 152
Ambiente 02 166
Ambiente 03 180

Tecnica 191

Specialisti della professionalità

Fondata nel 1996, fin dalla sua nascita Walco ha come mission creare e produrre arredi per il settore office dal design esclusivo e funzionale. Soluzioni realizzate per essere eterne, modulari e personalizzabili così da poter esprimere lo stile di ognuno.

Professional Specialists

Founded in 1996, Walco's mission since its start has been to create and produce office furniture with an exclusive and functional design. Solutions made to be timeless, modular and customisable so that everyone's style can be expressed.

Experts de la professionalité

Fondée en 1996, Walco a comme mission depuis son ouverture de créer et de produire des meubles de bureau exclusifs et fonctionnels. Des solutions réalisées pour être inaltérables, modulables et personnalisables afin que le style de chacun puisse s'exprimer.

AFFIDABILITÀ / RELIABILITY / FIABILITÉ
ASSISTENZA / ASSISTANCE / ASSISTANCE
FLESSIBILITÀ / FLEXIBILITY / FLEXIBILITÉ





Made in Italy ad alto tasso di funzionalità

Situata nel cuore del distretto del mobile Veneto, Walco ha adottato un approccio produttivo integrale. Ogni prodotto è concepito, realizzato e montato all'interno degli stabilimenti Walco, più di 20.000 mq che ospitano impianti all'avanguardia. Il risultato è un lavoro su commessa dove forma e funzione incontrano l'affidabilità e il know-how di un'azienda solida e sempre presente.

Made in Italy with a high level of functionality

Located in the heart of the Veneto furniture district, Walco has adopted an integral manufacturing approach. Every product is designed, manufactured and assembled in Walco's own factories, more than 20,000 square metres housing the latest technology. The result is a commissioned project where form and function meet the reliability and know-how of a solid, always present company.

Fabriqué en Italie avec un haut taux de fonctionnalité

Située au cœur de la région du meuble du Veneto, Walco a adopté une approche de fabrication intégrale. Chaque produit est développé, fabriqué et assemblé dans les établissements de Walco, qui s'étendent sur plus de 20 000 mètres carrés et sont dotés d'équipements extrêmement modernes. Le résultat est un travail sur mesure où la forme et la fonction rencontrent la fiabilité et le know-how d'une entreprise solide et toujours présente.

PERSONALIZZAZIONE / PERSONALISATION / PERSONNALISATION
FATTO SU MISURA / CUSTOM MADE / FAIT SUR MESURE



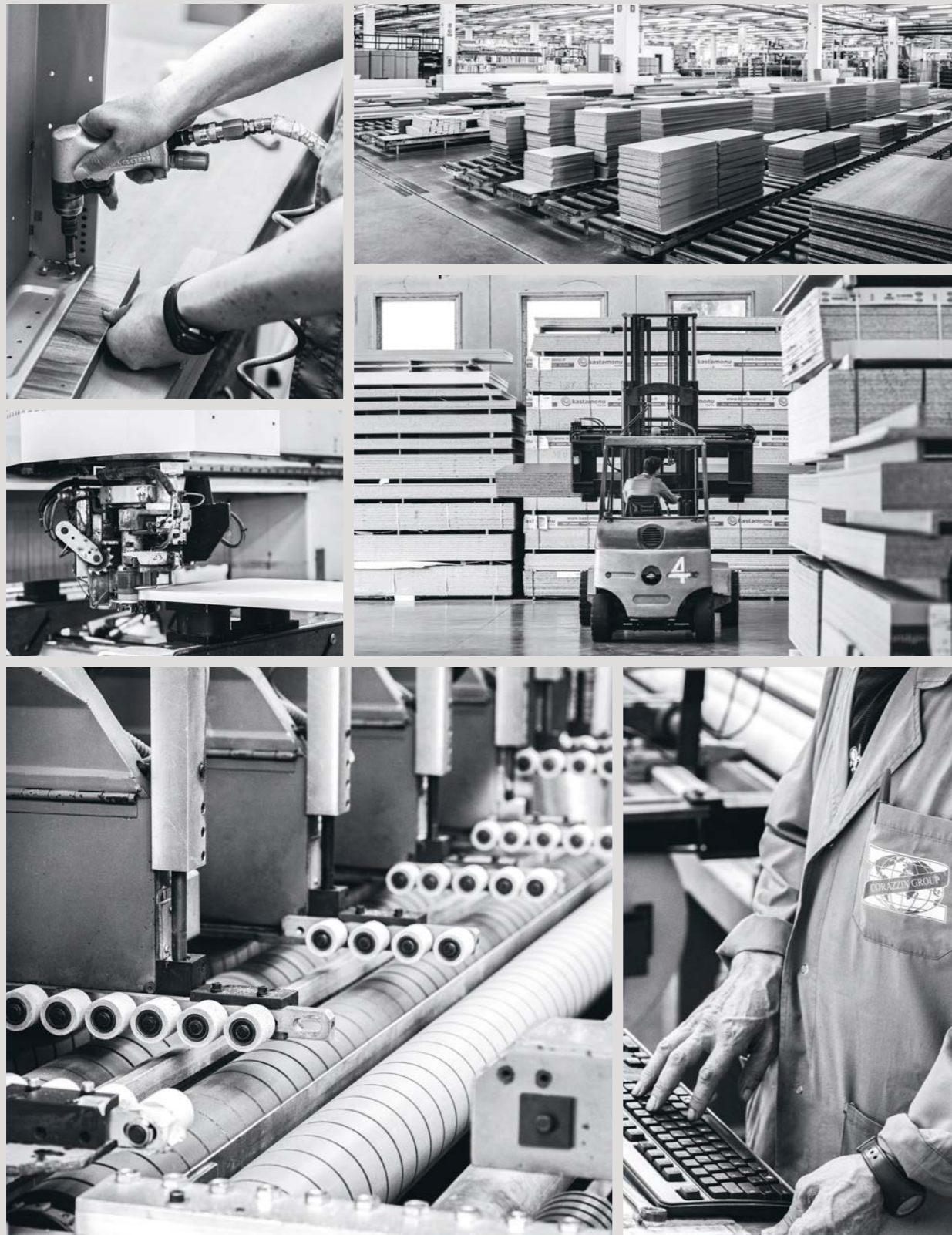

Ricerca e materiali
per soluzioni che durano nel tempo

La costante ricerca tecnologica di Walco fa sì che nella produzione siano utilizzati solo materiali di alta qualità, testati e garantiti per durare nel tempo. Attenzione alla sostenibilità, utilizzo di materie prime riciclate e a loro volta riciclabili, uso di finiture e soluzioni all'avanguardia, sono i dettagli che fanno la differenza e rendono gli arredi Walco intatti e solidi come il primo giorno, anche se smontati e rimontati.

Research and materials
for solutions that last in time

Walco's constant technological research ensures that only high quality materials are applied in production, tested and guaranteed to last over time. The attention to sustainability, the use of recycled and in their turn recyclable raw materials, the use of advanced finishes and solutions, these are the details that make the difference and make Walco furniture appear intact and as solid as on the first day, even when disassembled and reassembled.

Recherche et matériaux
pour des solutions durables

La recherche technologique constante de Walco garantit que seuls des matériaux de haute qualité sont utilisés dans la production, testés et garantis pour durer dans le temps. L'attention apportée à la soutenabilité, l'utilisation de matières premières recyclées et à leur tour recyclables, l'utilisation de finitions et de solutions modernes sont les détails qui font la différence et rendent les meubles Walco aussi intacts et solides qu'au premier jour, même s'ils sont démontés et réassemblés.

MATERIALI RICERCATI / SOPHISTICATED MATERIALS / DES MATERIAUX RECHERCHÉS
FINITURE ESCLUSIVE / EXCLUSIVE FINISHES / FINITIONS EXCLUSIVES
DESIGN / DESIGN / DÉSIGN



KRONOS

Ambiente 01

L'estetica di Kronos sottolinea la ricercatezza dei materiali utilizzati e come questi si possono combinare tra loro per un design esclusivo. Metallo, legno e vetro. Uniti in una composizione che mette in risalto la contrapposizione tra pieno e vuoto, trasparenze e opacità. Un sapiente mix perfettamente bilanciato. L'iconica base con gamba a T orizzontale, chiusa e cromata, sorregge il piano realizzato in vetro temperato trasparente e pannello impiallacciato vero legno Rovere Carbone. Un leitmotiv che si incontra anche nella composizione dei tavoli riunione e che si accompagna ad elementi d'arredo dal design ricercato come il divano angolare.

The aesthetics of Kronos focus on the refinement of the materials used and how they can be combined for an exclusive design. Metal, wood and glass. Together in a composition that underlines the contrast between empty and full, transparency and opacity. A perfectly balanced mix. The distinctive base with closed, chrome-plated horizontal T-leg supports the top made of transparent tempered glass and Rovere Carbone melamine. This theme is also evident in the composition of the meeting tables and is matched by furniture elements with a sophisticated design such as the corner sofa.

L'esthétique de Kronos accentue la sophistication des matériaux utilisés et la façon dont ils peuvent être combinés pour créer un design exclusif. Métal, bois et verre. Unis dans une composition qui souligne le contraste entre le plein et le vide, la transparence et l'opacité. Un dosage intelligent et parfaitement équilibré. La base iconique avec le pied en T horizontal, fermé et chromé, soutient le plateau en verre trempé transparent et en mélamine Rovere Carbone. On trouve également ce thème dans la composition des tables de réunion et il est complété par des éléments de meubles au design sophistiqué, tels que le canapé d'angle.

Scrivania con piano impiallacciato legno Rovere Carbone e vetro Trasparente, gonna alta e struttura Cromo.

Desk with Rovere Carbone wood veneer top and Transparent glass, high back panel and Chrome frame.

Bureau avec plateau en placage de bois de Rovere Carbone et verre transparent, panneau arrière haut et cadre chromé.







**Madia impiallacciato
legno Rovere Carbone
con basamento Cromo.**

Sideboard veneered in
Rovere Carbone with
Chrome base.

Buffet en placage de bois
Rovere Carbone avec
base chromée.

Scrivania impiallacciato legno
Rovere Fumo con gonna a terra
e struttura colore Nero.

Desk in Rovere Fumo veneer with
floor back panel and Nero frame.

Bureau en placage de Rovere
Fumo avec panneau arrière au
sol et cadre Nero.







Tavolo riunione componibile con piano impiallacciato legno Rovere Carbone e vetro Trasparente, gonna a terra per passacavi con struttura Cromo.

Modular meeting table with top in Rovere Carbone wood veneer and Transparent glass, floor back panels for cable conducts with Chrome frame.

Table de réunion modulaire avec plateaux en placage de bois Rovere Carbone et verre Transparent, panneaux arrière au sol pour le passage des câbles avec structure chromée.



Madia impiallacciato legno Rovere Carbone con inserto laccato Bianco e basamento Cromo.

Sideboard in Rovere Carbone veneer with Bianco lacquered insert and Chrome base.

Buffet en placage Rovere Carbone avec insert laqué Bianco et base chromée.

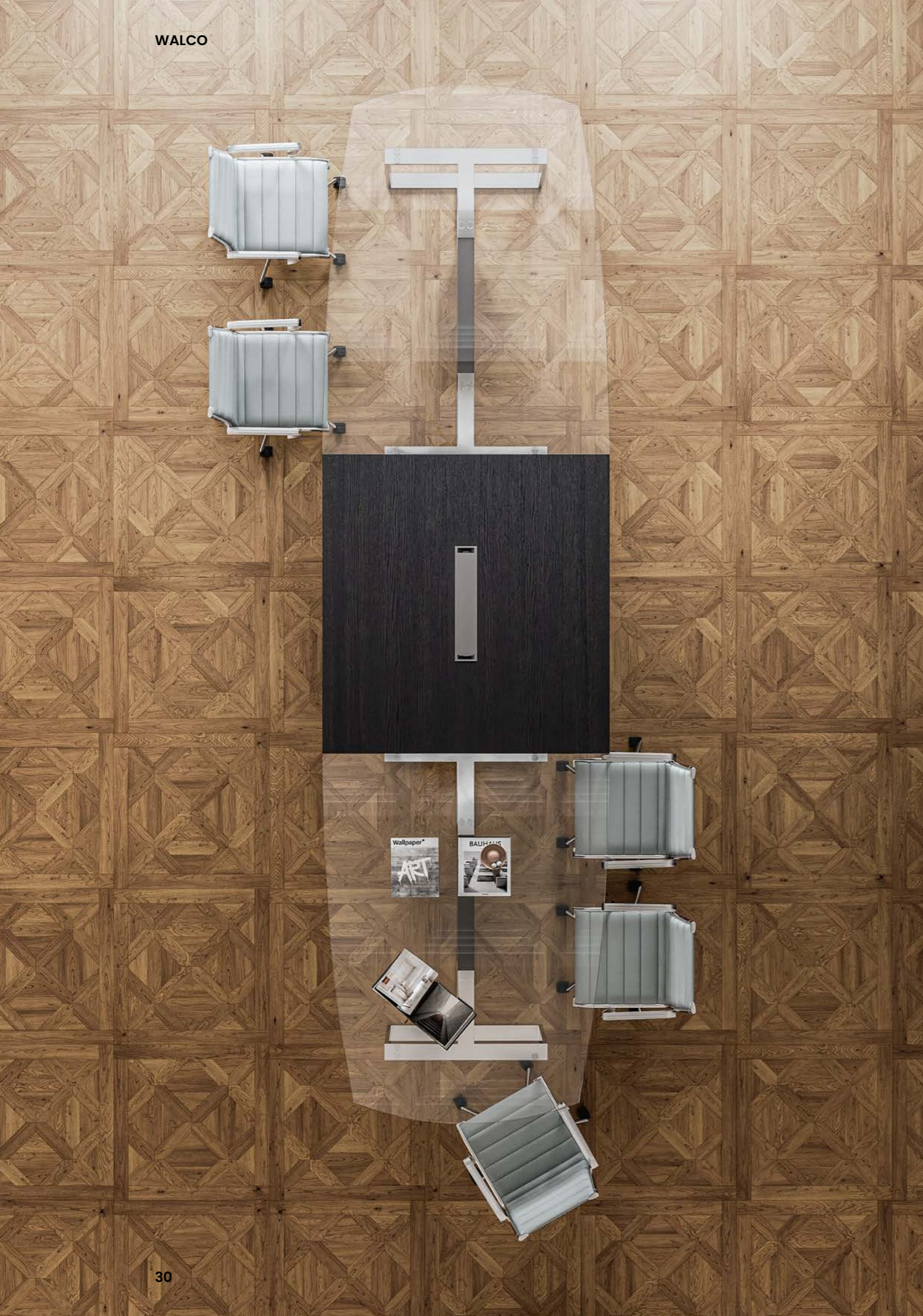

**Piano centrale impiallaciato
legno Rovere Carbone con
passacavi.**

Central top veneered in
Rovere Carbone wood with
cable duct.

Plateau central en placage
de bois de Rovere Carbone
avec conduit de câbles

Tavolo riunione componibile in finitura Marmo Nero Marquinia e vetro retrolaccato Bianco con struttura colore Nero.

Modular meeting table in Nero Marquinia marble finish and Bianco back-lacquered glass with Nero structure.

Table de réunion modulable en finition marbre Nero Marquinia et verre rétrolaqué Bianco avec structure Nero.

Madie con frontali in finitura Marmo Bianco Canova e inserto laccato Nero opaco.

Sideboards with fronts in Bianco Canova Marble finish and matt Nero lacquered insert.

Buffets avec façades en marbre Bianco Canova et insert laqué Nero mat.

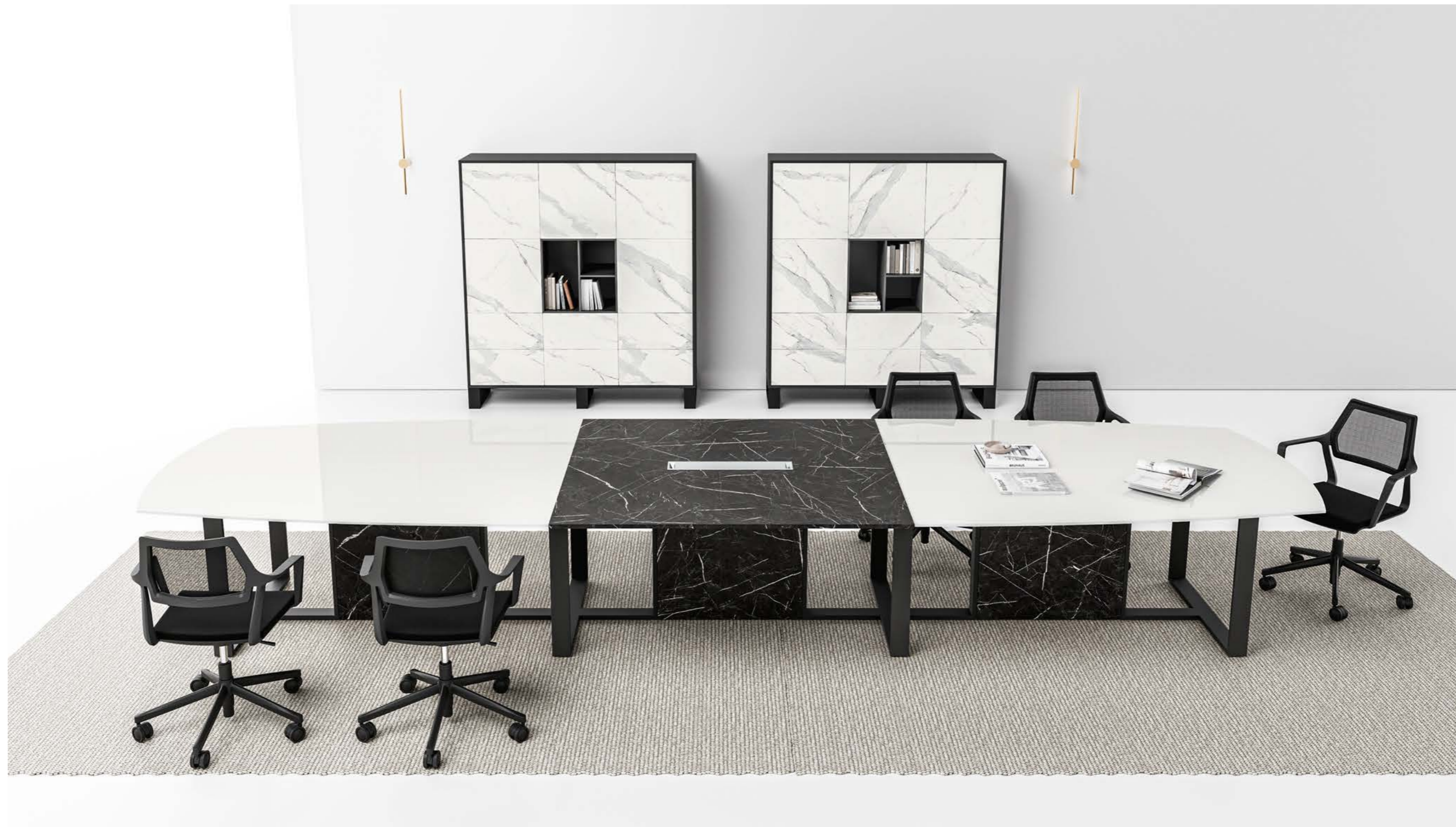



KRONOS

Ambiente 01

Scrivania Desk Bureau

Pag. 20

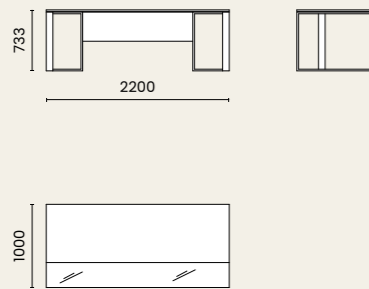

Scrivania Desk Bureau

Pag. 24

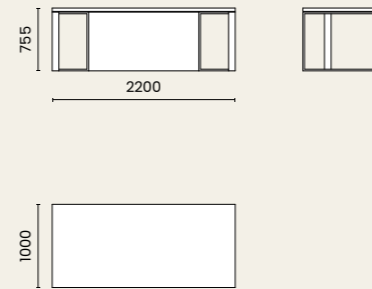

Tavolo riunione componibile Modular meeting table Table de réunion modulable

Pag. 26

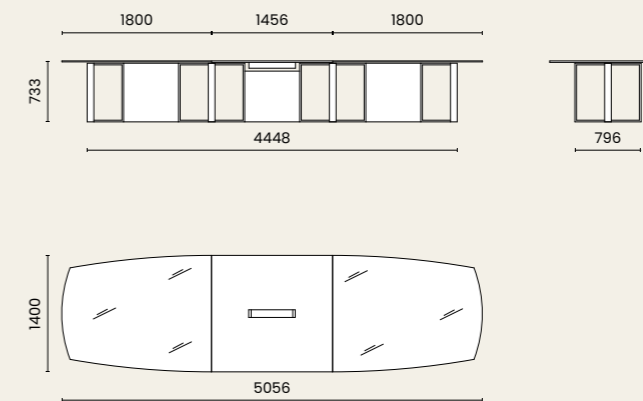

Madia Aura Aura sideboard Buffet Aura

Pag. 29

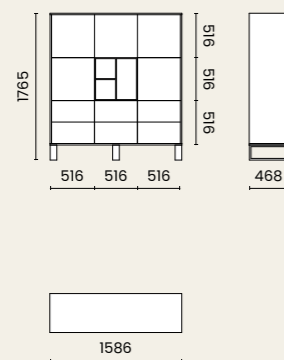

Madia Aura Aura sideboard Buffet Aura

Pag. 22

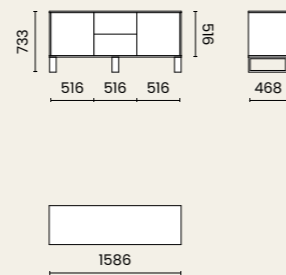

Tavolo riunione componibile Modular meeting table Table de réunion modulable

Pag. 32

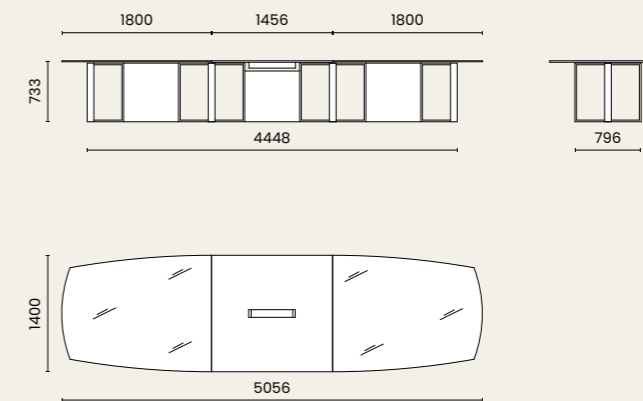

KRONOS

Ambiente 02

Essenziale ed accattivante. La versione Nero Opaco della gamba a T chiusa disegna una cornice ipnotica. Basta la sua essenzialità ad arredare lo spazio, grazie al colore pieno protagonista assoluto, abbinato ad un piano in vetro, l'elemento che dona luce e leggerezza alla composizione finale. Kronos si accompagna ad elementi d'arredo come la libreria Stem, in finitura Metal Grey. Leggera ed elegante, divide gli spazi senza ostacolare la luce nell'ambiente. Il tocco di colore è dato dalla seduta Bloom con schienale a tutta altezza.

Essential and attractive. The matt Nero version of the closed T-leg draws a hypnotic frame. Its essentiality is enough to furnish the space, thanks to the full colour that is the absolute protagonist, combined with a glass top, the element that gives light and lightness to the final composition. Kronos is accompanied by furnishing elements such as the Stem bookcase, in Metal Grey finish. Light and elegant, it divide the space without obstructing the light in the room. The touch of colour is given by the Bloom seat with full-height backrest.

Essentiel et attractif. La version Nero mat du pied en T fermé dessine un cadre hypnotique. Son essentialité suffit à meubler l'espace, grâce à la couleur pleine qui est le protagoniste absolu, associée à un plan en verre, l'élément qui donne de la lumière et de la légèreté à la composition finale. Kronos est accompagné d'éléments d'ameublement tels que la bibliothèque Stem, en finition Metal Grey. Légère et élégante, elle sépare l'espace sans obstruer la lumière de la chambre. La touche de couleur est apportée par le siège Bloom avec dossier pleine hauteur.

Tavolo riunione con piano in vetro
Trasparente, gamba a terra Noce
Smoke e struttura colore Nero.

Meeting table with Transparent glass
top, Noce Smoke floor standing back
panel and Nero frame.

Table de réunion avec plateau en
verre Transparent, panneau au sol
en Noce Smoke et structure Nero.









Scrivania con piano in vetro
retrolaccato Nero, gonna alta
Noce Smoke e struttura colore Nero.

Desk with Nero back-lacquered
glass top, tall Noce Smoke back
panel and Nero frame.

Bureau avec plateau en verre
laqué Nero, panneau arrière
haute en Noce Smoke et
structure Nero.

Scrivania con piano e gonna
impiallacciato legno Rovere Fumo.

Desk with top and back panel in Rovere
Fumo wood veneer.

Bureau avec plateau et panneau arrière
en placage de bois de Rovere Fumo.

Madia per scrivania impiallacciato legno
Rovere Fumo con basamento colore Nero.

Sideboard for desk in Rovere Fumo veneer
with Nero base.

Buffet pour bureau en placage de Rovere
Fumo avec base Nero.





Libreria Stem con ripiani, elementi a ribalta e cassetti Noce Smoke.

Stem bookcase with shelves, flap elements and drawers Noce Smoke.

Bibliothèque Stem avec étagères, éléments à abattants et tiroirs Noce Smoke.





Tavolo riunione componibile con piani in vetro Trasparente, gonne a terra Noce Smoke e struttura colore Nero.

Modular meeting table with Transparent glass tops, Noce Smoke floor standing back panel and Nero frame.

Table de réunion modulaire avec plateaux en verre transparent, panneaux arrière au sol en Noce Smoke et structure Nero.



KRONOS

Ambiente 02

Scrivania Desk Bureau

Pag. 44

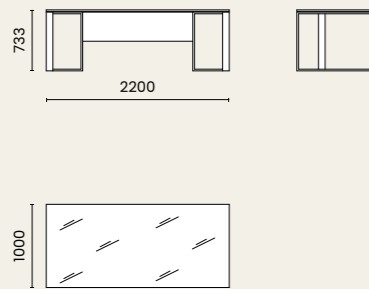

Scrivania Desk Bureau

Pag. 46

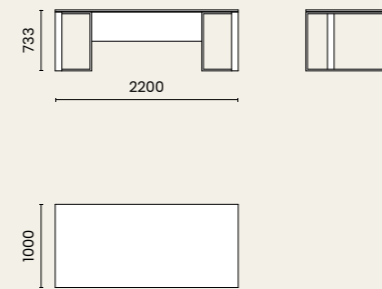

Tavolo riunione Meeting table Table de réunion

Pag. 40

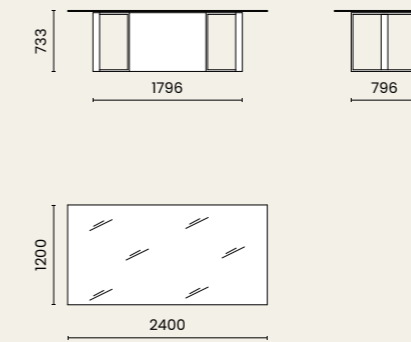

Tavolo riunione componibile Modular meeting table Table de réunion modulable

Pag. 52

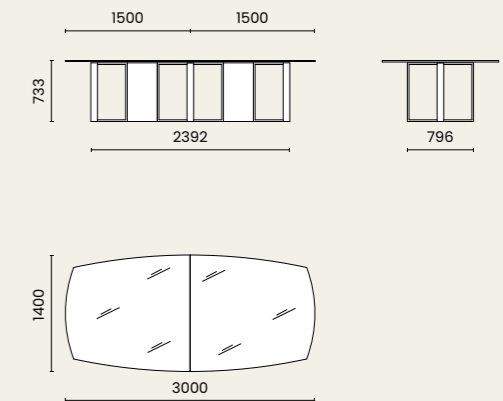

Libreria Stem Stem Bookcase Bibliothèque Stem

Pag. 49

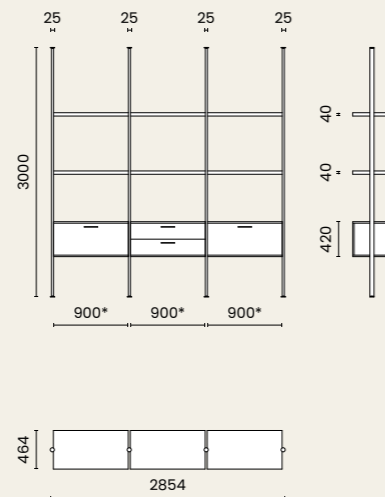

*dimensione mobile
*mobile size
*taille mobile

Cassettiera Pedestals Caissons

Pag. 43

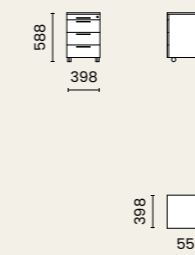

Madia per scrivania Aura Sideboard for Aura desk Buffet pour bureau Aura

Pag. 47

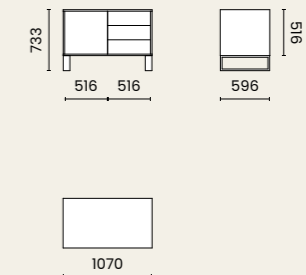

KRONOS

Ambiente 03

Kronos è avanguardia. Stile ed esclusività che si manifestano in linee pulite, decise e definite. Kronos è una composizione realizzata con elementi dai tratti nuovi e inediti, tra i quali, il più rappresentativo, è la base realizzata con gamba a T orizzontale chiusa, cromata o verniciata nera effetto opaco. Leggera, squadrata, sintetica. La perfetta armonia compositiva della scrivania Kronos si realizza con un piano di 18 o 40 mm in melaminico o 12 mm in vetro temperato e gonna pannellata che può avere funzione di canalizzazione. La serie si completa con armadi, tavoli riunione e madie nelle stesse finiture di pregio e con un richiamo alla sospensione, data dalla gamba chiusa, di tutti gli elementi.

Kronos is forefront. Style and exclusivity that manifest themselves in clean, decisive and defined lines. Kronos is a composition made up of elements with new and unprecedented features, the most representative of which is the base with a closed horizontal T-leg, chrome-plated or matt Nero painted. Light, square, synthetic. The perfect compositional harmony of the Kronos desk is realized with an 18 or 40 mm top in melamine or 12 mm in tempered glass and a panelled back panel that can function as a cable channel. The series is completed with wardrobes, meeting tables and sideboards in the same fine finishes and with a reference to the suspension, given by the closed leg, of all the elements.

Kronos, c'est l'avant-garde. Un style et une exclusivité qui se manifestent par des lignes nettes, décisives et définies. Kronos est une composition d'éléments aux caractéristiques nouvelles et inédites, dont le plus représentatif est la base avec un pied en T horizontal fermé, chromé ou peint en Nero mat. Léger, carré, synthétique. L'harmonie parfaite de la composition du bureau Kronos est obtenue grâce à un plateau de 18 ou 40 mm en mélamine ou de 12 mm en verre trempé et à un panneau arrière en bois qui peut être utilisée comme un conduit. La série est complétée par des armoires, des tables de réunion et des buffets dans les mêmes finitions raffinées et avec une référence à la suspension, donnée par le pied fermé, de tous les éléments.



Scrivania con piano e gonna alta
Noce Moka, struttura Cromo.

Desk with Noce Moka top and
high back panel, Chrome frame.

Bureau avec plateau en Noce
Moka et panneau arrière haute,
structure chromée.





**Madia Aura Noce Moka con
inserti laccato Rosso Rubino
e basamento Cromo.**

Aura Noce Moka sideboard
with Rosso Rubino lacquered
inserts and Chrome base.

Buffet Aura en Noce Moka
avec inserts laqués Rosso
Rubino et base chromée.

**Madia Aura Noce Moka
con basamento Cromo.**

Aura Noce Moka sideboard
with Chrome base.

Buffet Aura en Noce Moka
avec base chromée.



**Tavolo Noce Moka con
basamento Cromo.**

Noce Moka table with
Chrome base.

Table en Noce Moka avec
base chromée.





Scrivania con piano micro rivestito soft touch opaco Black, gonnna alta Noce Moka e struttura colore Nero.

Desk with micro top covered soft touch matt Black, tall Noce Moka back panel and Nero frame.

Bureau avec plateau micro recouvert soft touch Black mat, panneau arrière haute en Noce Moka et cadre Nero.

Madia Aura Noce Moka con inserti laccato Nero e basamento colore Nero.

Aura Noce Moka sideboard with Nero lacquered inserts and Nero base.

Buffet Aura en Noce Moka avec inserts laqués Nero et base Nero.





Tavolo riunione componibile con piani e gonne a terra Noce Moka. Struttura Cromo.

Noce Moka modular meeting table with tops and floor standing back panels. Chrome frame.

Table de réunion modulaire en Noce Moka avec plateaux et panneaux arrière au sol. Structure chromée.



KRONOS

Ambiente 03

Scrivania Desk Bureau

Pag. 58

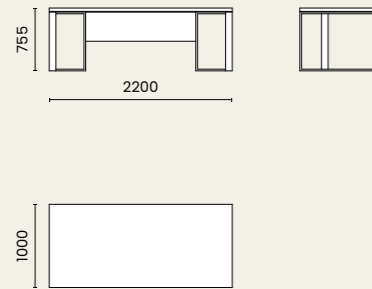

Scrivania Desk Bureau

Pag. 66

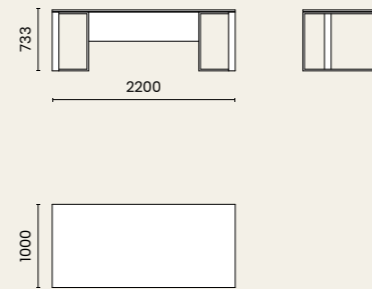

Madia Aura Aura sideboard Buffet Aura

Pag. 58

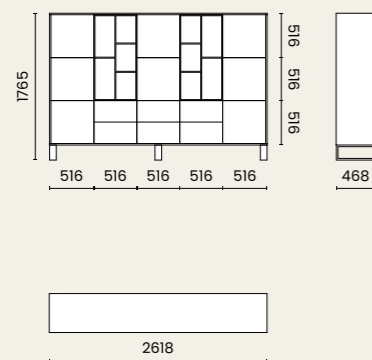

Madia Aura Aura sideboard Buffet Aura

Pag. 67

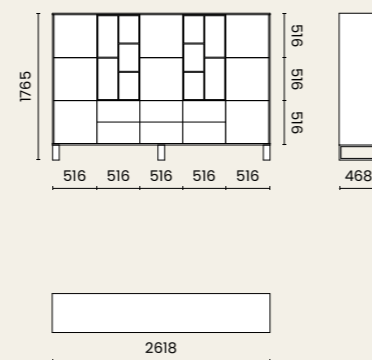

Tavolo riunione componibile Modular meeting table Table de réunion modulable

Pag. 69

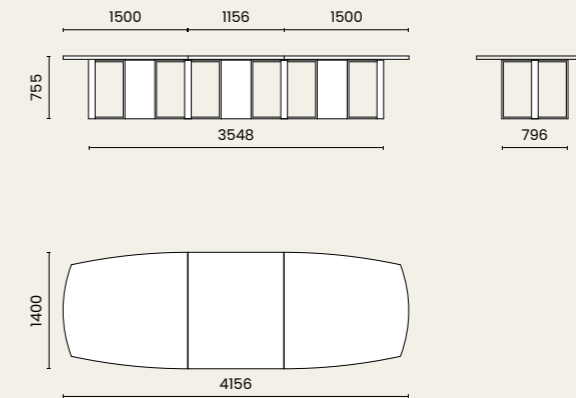

Tavolo circolare Round table Table ronde

Pag. 63

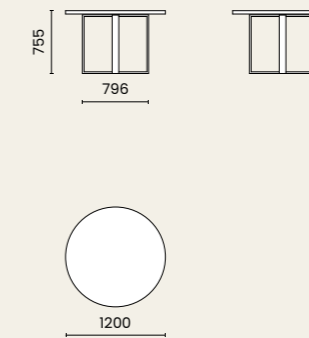

Madia Aura Aura sideboard Buffet Aura

Pag. 62

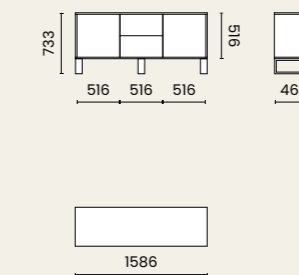

VELA

Ambiente 01

La collezione Vela è un must tra le proposte Walco famosa per i suoi piani sagomati a vela o a botte e per l'imponente colonna di sostegno dalla forma esagonale. Vela è una scrivania che esalta lo stile classico, che può essere ancora più enfatizzato scegliendo finiture di pregio, come il legno o la pelle con cui rivestire i vari elementi. Nel grande piano a vela, la sinuosità del disegno ad arco è impreziosita da una lavorazione a due spessori con un sottopiano di 18 mm laccato, disponibile nei laccati a campionario, che si abbina al piano in melaminico o impiallacciato in vero legno con spessore 18 mm e permette di creare originali accostamenti cromatici.

The Vela collection is a popular must-have among Walco's offerings, famous for its shaped sail or barrel tops and the majestic hexagonal-shaped support column. Vela is a composition that exalts the classic style, which can be even more accentuated by choosing prestigious finishes, such as wood or leather with which to cover the various elements. In the large sail-shaped top, the arching design's sinuosity is made more precious by a two-thickness workmanship with an 18 mm thick lacquered undercounter, available in the lacquered finishes in the sample collection, which matches the 18 mm thick melamine or solid wood veneer top and makes it possible to create original colour combinations.

La collection Vela est un "must" de l'offre Walco, célèbre pour ses plateaux en forme de voile ou de baril et l'imposante colonne de soutien de forme hexagonale. Vela est une composition qui met en valeur le style classique, que l'on peut encore renforcer en choisissant des finitions raffinées, comme le bois ou le cuir, pour recouvrir les différents éléments. Dans le grand plateau "vela", la sinuosité de l'arc est mise en valeur par un traitement en deux épaisseurs, avec un plateau inférieur laqué de 18 mm d'épaisseur, disponible dans les laques de la collection d'échantillons, qui s'harmonise avec le plateau en mélaminé ou en placage de bois massif de 18 mm d'épaisseur et qui permet des combinaisons de couleurs originales.

Scrivania impiallacciato legno
Noce Canaletto con sottopiano
colore Nero e supporti colore
Grigio. Rivestimento gamba
esagonale in pelle P.917.

Desk in Noce Canaletto wood
veneer with Nero undercounter
and Grigio supports. Hexagonal
leather leg cover P.917.

Bureau en placage de Noce
Canaletto avec sous-comptoir
Nero et supports Grigio.
Revêtement des pieds en cuir
hexagonal P.917.







Scrivania impiallacciato legno Noce Canaletto con sottomano in pelle P.903.

Noce Canaletto wood veneered desk with leather desk pad P.903.

Bureau en placage de Noce Canaletto avec sous-main en cuir P.903.

Armadio Ark Plus impiallacciato legno Noce Canaletto con scocca laccato Verde Siria.

Ark Plus wardrobe in Noce Canaletto wood veneer with Verde Siria lacquered body.

Armoire Ark Plus en placage de Noce Canaletto avec corps laqué Verde Siria.

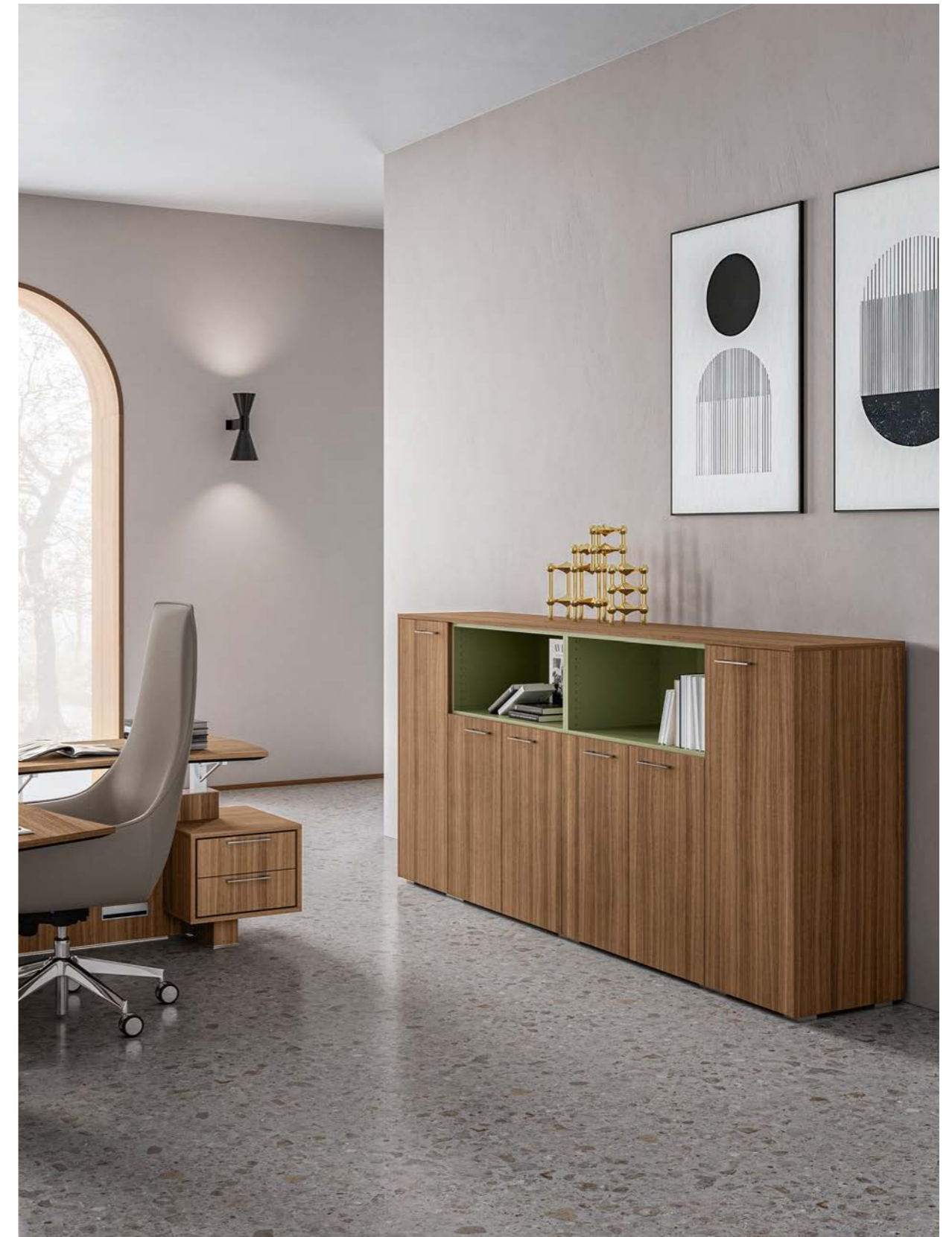







**Tavolo riunione
impiallacciato legno Noce
Canaletto e passacavi.**

Meeting table with Noce
Canaletto veneer and
cable duct.

Table de réunion plaquée
en Noce Canaletto avec
conduit des câbles.



VELA

Ambiente 01

Scrivania Day Day desk Bureau Day

Pag. 76

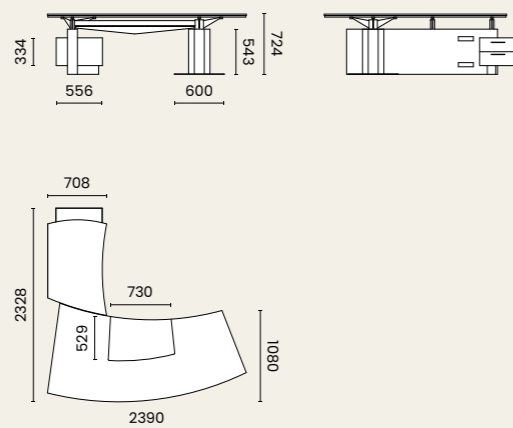

Armadio Ark Plus Ark Plus wardrobe Armoire Ark Plus

Pag. 79

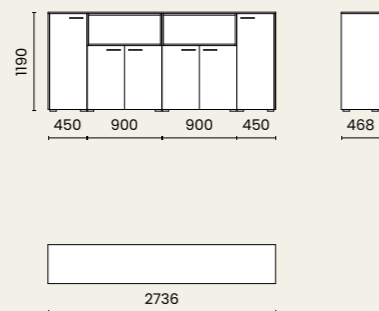

Tavolo Idea Idea table Table Idea

Pag. 82

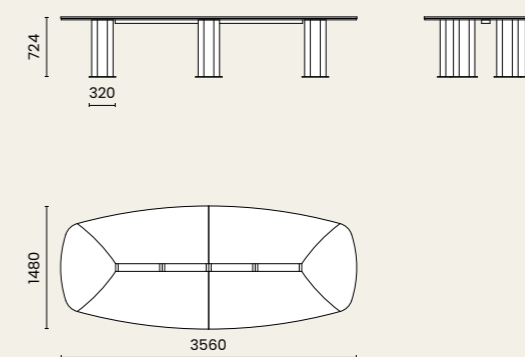

Armadio Ark Plus Ark Plus wardrobe Armoire Ark Plus

Pag. 86

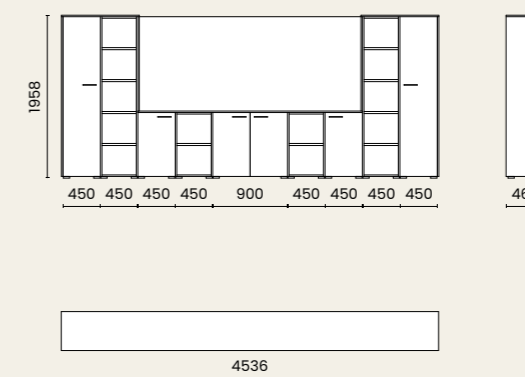

VELA

Ambiente 02

La scrivania Vela con piano sagomato a botte in vetro Trasparente extrachiaro e fianchi in melaminico effetto legno, si presenta con uno stile luminoso e leggero. Qui la tecnologia è messa in evidenza, con piccoli e grandi dettagli che ne fanno una composizione moderna, elegante e funzionale. Cassettera inserita nel corpo del muretto con effetto sospeso e scrivania elettrificata con muretto passacavi, per avere sempre tutto in ordine.

L'iconica colonna di sostegno è proposta anche per i tavoli riunione che possono essere di dimensioni diverse, con top in vetro trasparente, acidato, retrolaccato, oppure in melaminico o impiallacciato con vero legno.

The Vela version with a barrel-shaped glass top and wood-effect melamine sides is characterised by a light and bright style. In this case, technology is in evidence, with small and large details that make it a modern, elegant and functional composition. Chest of drawers built into the cabinet unit with a suspended effect, and an electrified desk with a cable-passing cabinet to keep everything in order. The distinctive support column is also proposed for the meeting tables, which can come in different sizes, with transparent, etched or back-lacquered glass tops, or in melamine or veneered with solid wood.

La version Vela, avec un plateau en verre en forme de baril et des côtés en mélaminé effet bois, a un style léger et lumineux. La technologie est ici mise en valeur, avec de petits et grands détails qui en font une composition moderne, élégante et fonctionnelle. Tiroir encastré dans le corps du meuble avec un effet de suspension et bureau électrifié avec un passe-câble pour que tout soit toujours bien rangé. L'emblématique colonne de support est également proposée pour les tables de réunion, qui peuvent être de différentes dimensions, avec des plateaux en verre transparent, dépoli rétro-laqué, ou encore en mélaminé ou en placage de bois massif.



Scrivania in Rovere rigato con piano in vetro Trasparente.

Rovere Rigato Desk with Transparent Glass Top.

Bureau en Rovere Rigato avec plateau en verre Transparent.





Scrivania in Rovere Rigato con piano in vetro Trasparente e supporti colore Grigio.

Desk in Rovere Rigato with Transparent glass top and Grigio supports.

Bureau en Rovere Rigato avec plateau en verre Transparent et supports Grigio.





Armadi Ark Rovere Rigato con frontali in finitura Marmo Canova.

Ark Rovere Rigato wardrobes with fronts in Canova marble finish.

Armoires Ark en Rovere Rigato avec façades en marbre Canova.





PICASSO
1932 09
LOVE
FAME
09 TRA
18 GEDY
TATE

1986-2003

OF ART
VICE

OF ART
VICE

1986-2003

OF ART
VICE

OF ART
VICE

OF ART
VICE

OF ART
VICE

OF ART
VICE

OF ART
VICE

OF ART
VICE

OF ART
VICE

OF ART
VICE

OF ART
VICE

OF ART
VICE

OF ART
VICE

OF ART
VICE

OF ART
VICE

OF ART
VICE

OF ART
VICE

OF ART
VICE



Gamba esagonale Rovere Rigato, piano vetro Trasparente e supporto colore Grigio.

Rovere Rigato hexagonal leg, Transparent glass top and Grigio support.

Pied hexagonal en Rovere Rigato, plan en verre Transparent et support Grigio.

VELA

Ambiente 02

Scrivania Nest Nest desk Bureau Nest

Pag. 92

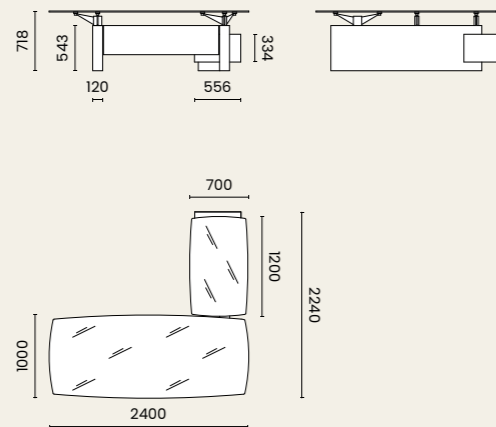

Armadio Ark Ark wardrobe Armoire Ark

Pag. 97

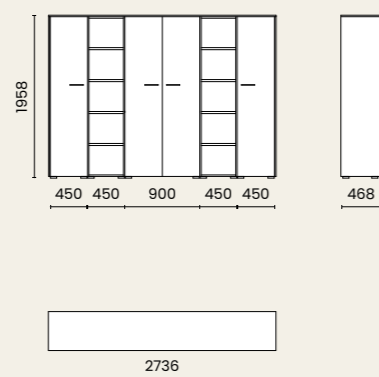

Armadio Ark Ark wardrobe Armoire Ark

Pag. 98

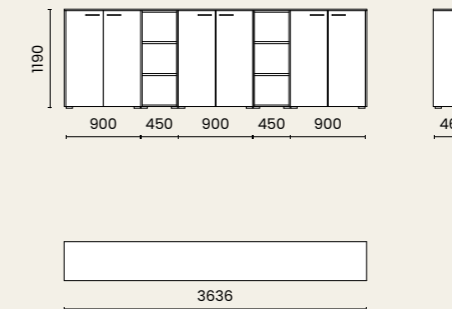

Tavolo circolare Round table Table ronde

Pag. 101

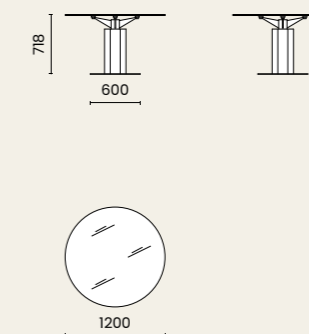

Armadio Ark Ark wardrobe Armoire Ark

Pag. 96

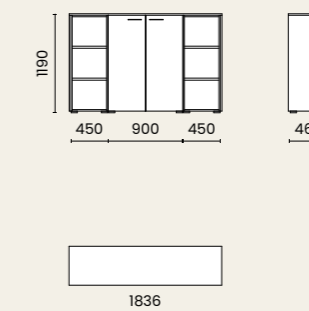

VELA

Ambiente 03

Il programma di scrivanie e tavoli riunione Vela può essere realizzato anche con i piani nelle nuovissime finiture ultra opache in melaminico micro rivestito soft touch (ad esclusione del sottopiano che rimane laccato), con lo speciale trattamento antimpronta. In questa composizione il piano sagomato a botte si accompagna al dattilo della stessa forma, entrambi in melaminico micro rivestito soft touch opaco White, mentre la struttura ed il gambone sono in finitura laccato Grigio Caldo. Con le stesse finiture vengono proposti anche il tavolo riunione Nest e le madie Aura.

You can also realise the Vela programme of desks and meeting tables with tops in the brand new ultra-matt micro-laminated melamine finishes (with the exclusion of the undercounter, which stays lacquered), with the special anti-touch treatment. In this composition, the barrel-shaped top goes with the dactyl of the same shape, both in white micro-coated melamine, while the structure and leg are in Grigio Caldo finish. The Nest meeting table and the Aura sideboards are also proposed in the same finishes.

La gamme de bureaux et de tables de réunion Vela peut également être réalisée avec des plateaux dans les toutes nouvelles finitions en mélamine micro-revêtue ultra-mate (à l'exception du plateau inférieur qui reste laqué), avec le traitement spécial anti-touch. Dans cette composition, le plateau en forme de baril est accompagné du dactyle de la même forme, tous les deux en mélamine micro-revêtue blanc, tandis que la structure et le pied sont en finition Grigio Caldo. La table de réunion Nest et les buffets Aura sont également proposés dans les mêmes finitions.



Scrivania con piani micro rivestito soft touch opaco White.

Desk with micro tops covered in soft touch matt White.

Bureau avec plateaux micro recouverts de White mat soft touch.



Struttura scrivania
laccata Grigio Caldo.

Grigio Caldo lacquered
desk frame.

Cadre de bureau laqué
Grigio Caldo.



Madia in micro rivestito soft
touch opaco White e inserto
laccato Grigio Caldo.

Sideboard in micro-coated soft
touch matt White and Grigio
Caldo lacquered insert.

Buffet en micro revêtement
soft-touch Blanc mat et insert
laqué Grigio Caldo.



Scrivania con piano micro rivestito soft touch opaco Black, sottopiano e struttura laccato Nero. Supporti e travi colore Nero.

Desk with top micro coated soft touch matt Black lacquered top and structure. Nero supports and beams.

Bureau avec plateau micro recouvert d'un revêtement soft touch Black mat, dessous de plateau et structure laqués Nero. Supports et poutres Nero.

Madia in finitura micro rivestito soft touch opaco Black con inserto laccato Giallo Sole.

Sideboard in micro soft touch matt Black finish with Giallo Sole lacquered insert.

Buffet en finition micro revêtement soft touch mat Black avec insert laqué Giallo Sole.







Madia Aura su zeppe laccato Grigio Caldo con inserto laccato Bianco.

Aura sideboard on Grigio Caldo lacquered wedges with Bianco lacquered insert.

Buffet Aura sur cales laquées Grigio Caldo avec insert laqué Bianco.

Tavolo con piano micro rivestito soft touch opaco White e sottopiano laccato Bianco. Gamba esagonale laccato Grigio Caldo con supporti colore Grigio.

Table with micro top coated soft touch matt White and Bianco lacquered under-top. Grigio Caldo lacquered hexagonal leg with Grigio supports.

Table avec plateau micro revêtement Soft Touch White mat et dessous de plateau laqué Bianco. Pied hexagonal laqué Grigio Caldo avec supports Grigio.



Tavolo con piano in vetro Acidato, gambe esagonali laccato Nero e supporti colore Grigio.

Table with acid-etched glass top, Nero lacquered hexagonal legs and Grigio supports.

Table avec plateau en verre dépoli, pieds hexagonaux laqués Nero et supports Grigio.

Madia micro rivestito soft touch opaco Black su zeppe con inserto laccato colore Bianco.

Sideboard micro coated soft touch matt Black on wedges with Bianco lacquered insert.

Buffet micro revêtement soft touch matt Black sur cales avec insert laqué Bianco.



VELA

Ambiente 03

Scrivania Nest Nest desk Bureau Nest

Pag. 106

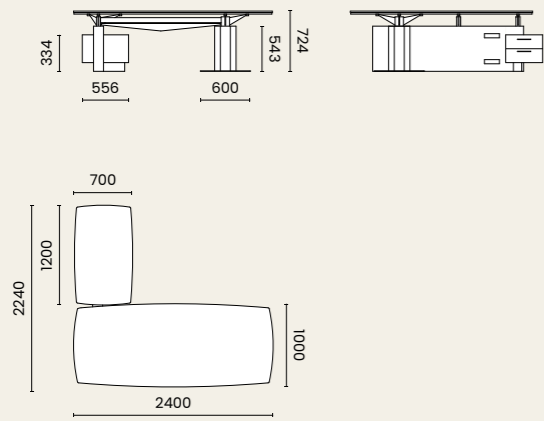

Scrivania Nest Nest desk Bureau Nest

Pag. 110

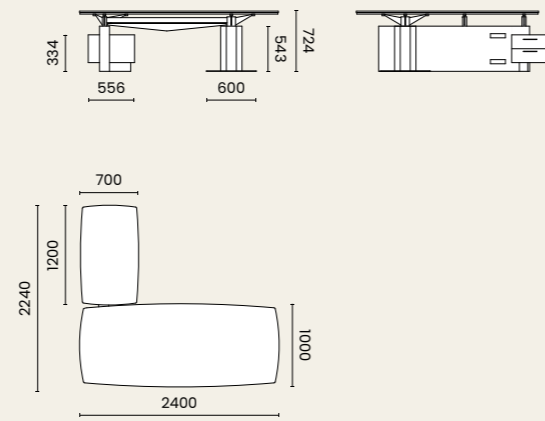

Tavolo Nest Nest table Table Nest

Pag. 112

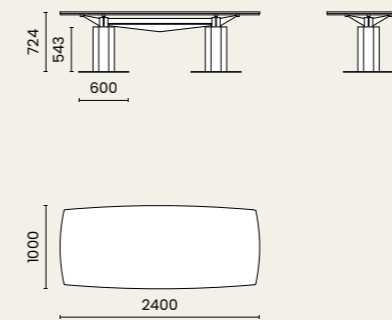

Tavolo Nest Nest table Table Nest

Pag. 116

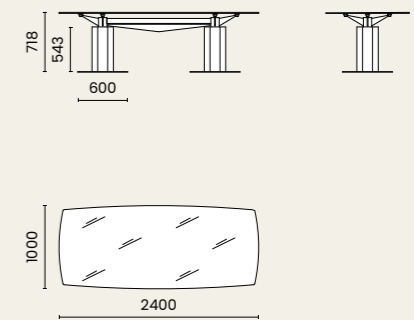

Madia Aura Aura sideboard Buffet Aura

Pag. 109

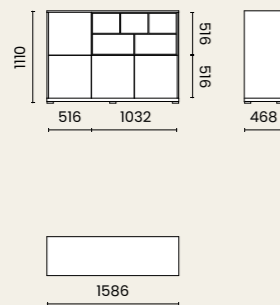

Madia Aura Aura sideboard Buffet Aura

Pag. 111

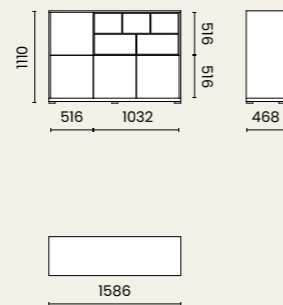

Madia Aura Aura sideboard Buffet Aura

Pag. 113

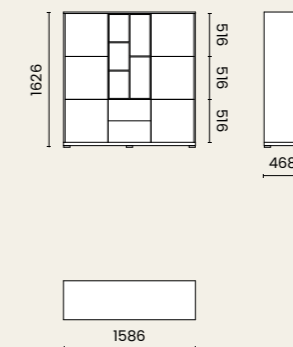

ALFA PLUS

Ambiente 01

Con la serie Alfa Plus lo spazio di lavoro si trasforma in un ambiente esclusivo dove, grazie alle tante combinazioni, è possibile dar vita a composizioni dallo stile personalizzato. L'ampia scrivania con fianchi pannellati può essere indipendente oppure poggiare su mobili di servizio, con o senza gonna. Uno dei tanti dettagli di classe è il distanziale in alluminio con finitura lucida che disegna il profilo dei vari elementi che compongono la scrivania.

With the Alfa Plus series, the work area is transformed into an exclusive environment where, thanks to the many combinations, customised compositions can be created. The large desk with panelled sides can be free-standing or rest on service base units, with or without a back panel. One of the many stylish details is the aluminium spacer with a polished finish that draws the profile of the various elements that make up the desk.

Avec la série Alfa Plus, l'espace de travail se transforme en un environnement exclusif où, grâce aux nombreuses combinaisons, il est possible de créer des compositions personnalisées. Le grand bureau aux côtés recouverts de panneaux peut être autonome ou posé sur un meuble de desserte, avec ou sans panneau arrière. Un des nombreux détails de qualité est la pièce d'écartement en aluminium avec une finition polie qui dessine le profil des différents éléments qui composent le bureau.



Tavolo Noce Mat. Armadio Logica
Grafite con frontali Noce Mat.

Table Noce Mat. Logica Grafite
Wardrobe with Noce Mat fronts.

Table Noce Mat. Armoire Logica
Grafite avec façades Noce Mat.



La gonna pannellata è lavorata con taglio diagonale, dando un tocco di leggerezza e movimento al disegno complessivo. La serie Alfa Plus si completa con elementi come il tavolo riunione rettangolare o circolare, il tavolino ribassato e varie soluzioni per il dattilo che può essere aggregabile a 90° o indipendente.

The back panel is cut diagonally, giving a touch of lightness and movement to the overall design.

The Alfa Plus range is completed with elements such as the rectangular or circular meeting table, the lowered coffee table and various solutions for the dactyl which can be combined at 90° or freestanding.

Le panneau arrière est réalisée avec une coupe diagonale, ce qui confère une touche de légèreté et de mouvement à l'ensemble du meuble. La série Alfa Plus est complétée par des éléments comme la table de réunion rectangulaire ou circulaire, la table basse et diverses solutions pour le dactyle qui peuvent être combinées à 90° ou indépendantes.

**Scrivania con gonna pannellata
Noce Mat. Mobile di servizio
grande con zoccolo Grafite.**

Desk with panelled back panel
Noce Mat. Large service base
unit with Grafite plinth.

Bureau avec panneau arrière
à panneaux Noce Mat. Grand
meuble de desserte avec socle
en Grafite.





Piano scrivania con passacavi large.

Desk top with large cable ducts.

Dessus de bureau avec grand conduit de câbles.



Scrivania Noce Moka con fianchi e
gonna pannellata in finitura Visone.

Noce Moka desk with sides and
panelled back panel in Visone finish.

Bureau en Noce Moka avec côtés et
panneau arrière en finition Visone.



ALFA PLUS

Ambiente 01

Scrivania con gonna pannellata e mobile di servizio

Desk with back panel and service base unit
Bureau avec panneau et meuble desserte

Pag. 122

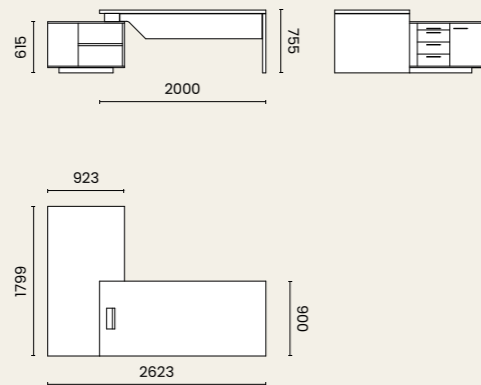

Scrivania con gonna pannellata

Desk with back panel
Bureau avec panneau

Pag. 130

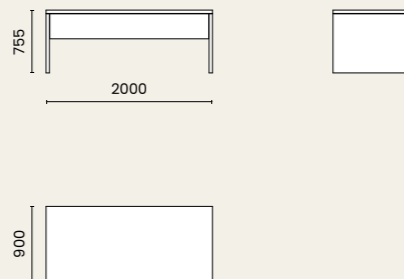

Armadi Logica Logica wardrobes Armoires Logica

Pag. 122

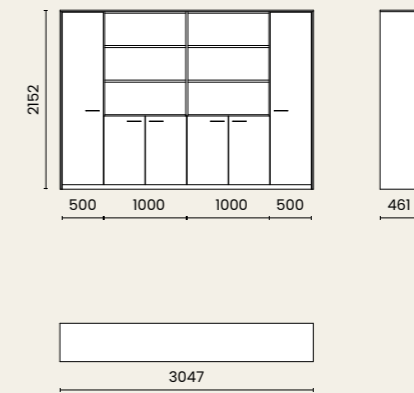

Tavolo riunione Meeting table Table de réunion

Pag. 128

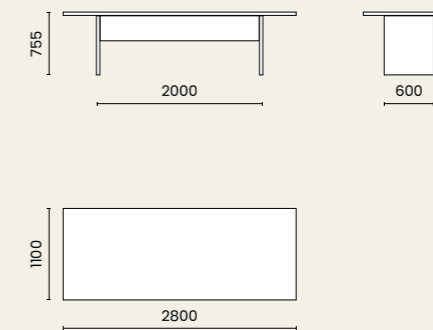

Armadi Logica Logica wardrobes Armoires Logica

Pag. 128

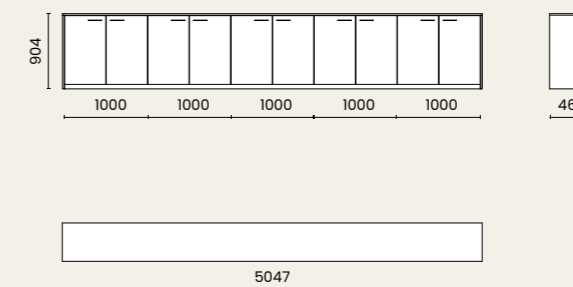

ALFA PLUS

Ambiente 02

La scrivania Alfa Plus con piano impiallacciato vero legno Rovere Argilla e gonnata pannellata dal taglio diagonale, qui si presenta con il caratteristico appoggio ibrido, da un lato pannello, dall'altro mobile di servizio in finitura laccato Beige. A chiudere la composizione generale si affiancano alla scrivania l'armadio Logica, la libreria Stem e il tavolo Bruce.

Logica è un imponente armadio componibile e modulare con struttura di 25 mm di spessore che può essere inserito come armadio oppure come parete attrezzata, tamponato sul soffitto, con zoccolo metallico.

The Alfa Plus desk with veneered top in Rovere Argilla wood and back panel diagonally cut, here comes with the characteristic hybrid support, on one side panel, on the other side service base unit in Beige lacquered finish. The general composition is completed by the Logica wardrobe, the Stem bookcase and the Bruce table.

Logica is an imposing, modular wardrobe with a 25 mm thick structure that can be placed as a wardrobe or as equipped wall unit, closed on the ceiling, with a metal plinth.

Le bureau Alfa Plus avec le plan plaqué en Rovere Argilla massif et le panneaux arrière coupés en diagonale, est présenté ici avec le support hybride caractéristique, d'un côté panneau, de l'autre meuble desserte en finition laquée Beige.

La composition générale est complétée par l'armoire Logica, la bibliothèque Stem et la table Bruce.

Logica est une imposante armoire modulaire avec une structure de 25 mm d'épaisseur qui peut être insérée comme une armoire ou comme une unité murale, enfichée au plafond, avec un socle en métal.



Scrivania pannellata impiallacciato legno Rovere Argilla. Mobile di servizio piccolo con zoccolo laccato Beige.

Panelled desk with Rovere Argilla wood veneer. Small service base unit with Beige lacquered plinth.

Bureau à panneaux plaqué en Rovere Argilla. Petit meuble de desserte avec socle laqué Beige.





Profili di finitura in alluminio lucido. Frontali mobile di servizio impiallacciato legno Rovere Argilla.

Polished aluminium finishing profiles. Service base units fronts in Rovere Argilla wood veneer.

Profils de finition en aluminium poli. Façades des meubles de desserte en placage de bois de Rovere Argilla.







Bruce è il tavolo sviluppato per Alfa Plus realizzato aggregando i mobili di accosto Robin, uniti con travi metalliche, che acquisiscono una doppia funzione: basamento del tavolo e pratici contenitori. Un tavolo modulare che può avere varie dimensioni, elettrificabile, dotato di passacavi.

Bruce is the table designed for Alfa Plus created by assembling the Robin side by side furniture, joined with metal beams, which acquire a dual function: table base and practical containers. A modular table that can come in various sizes, can be electrified, and is equipped with cable entry tops.

Bruce est la table développée pour Alfa Plus. Elle est le résultat de l'assemblage du meuble Robin, relié à des poutres métalliques, qui acquièrent une double fonction: base de table et rangement pratique. Une table modulaire qui peut être de différentes tailles, électrifiée et équipée d'un plateau d'accès aux câbles.



Piano tavolo Bruce in finitura impiallacciato legno Rovere Argilla con passacavi. Mobili di supporto tavolo con zeppe laccato Beige.

Bruce table top in Rovere Argilla wood veneer finish with cable ducts. Table support furniture with Beige lacquered wedges.

Dessus de table Bruce en placage de bois Rovere Argilla avec conduit de cables. Meuble support de table avec cales laquées Beige.

Stem è una leggerissima ed elegante libreria, sviluppata su solidi tubolari in alluminio finitura Metal Grey elettrificati a LED con larghezza fissa e composizione a soffitto.

Stem is an extremely light and elegant bookcase, developed on solid aluminium tubes in Metal Grey finish electrified with LEDs with a fixed and ceiling mounted composition.

Stem est une bibliothèque extrêmement légère et élégante, développée sur de solides tubes d'aluminium avec une finition Metal Grey électriifiée par des LEDs avec une largeur fixe et une composition au plafond.



Scrivania pannellata Noce Smoke con fianchi e gonna Grafite. Profili di finitura in alluminio lucido.

Noce Smoke panelled desk with sides and back panel Grafite. Aluminium polished finish profiles.

Bureau avec panneaux en Noce Smoke, côtés et panneau arrière en Grafite. Profils de finition en aluminium poli.



ALFA PLUS

Ambiente 02

Scrivania con gonna pannellata | Mobile di servizio piccolo con zoccolo

Desk with back panel | Little service base unit with plinth
Bureau avec panneau | Petit meuble desserte avec socle

Pag. 136

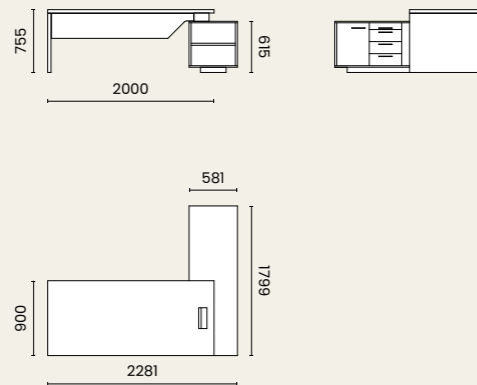

Scrivania con gonna pannellata

Desk with back panel
Bureau avec panneau

Pag. 148

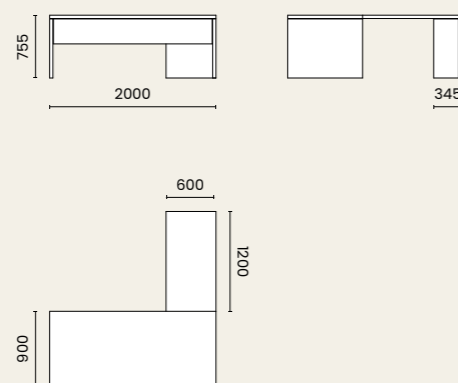

Armadio bifacciale Logica

Double-sided wardrobe Logica
Armoire double face Logica

Pag. 136

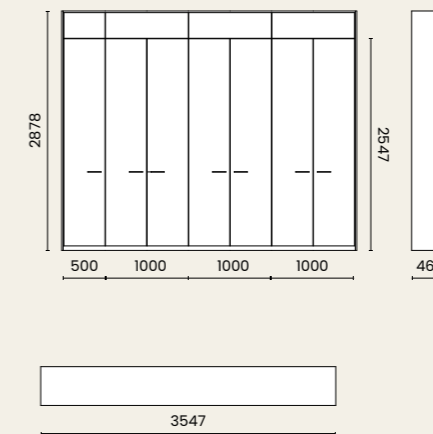

Tavolo componibile Bruce

Bruce modular table
Table modulable Bruce

Pag. 140

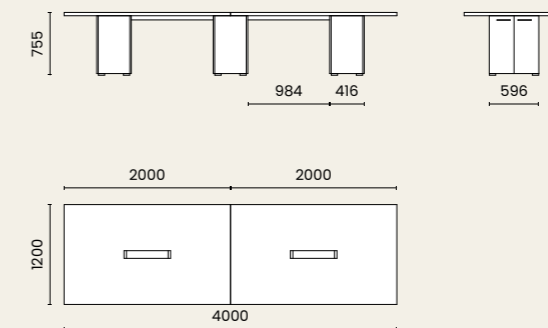

Libreria Stem

Wardrobes Stem
Armoires Stem

Pag. 147

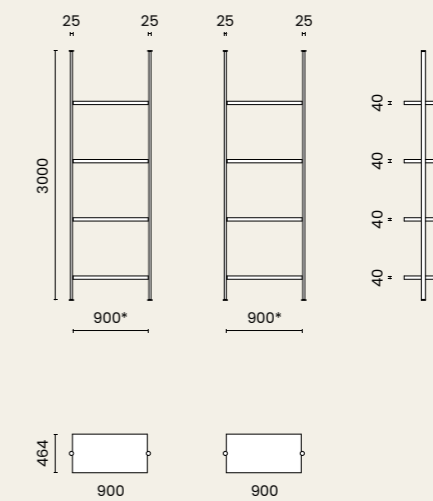

*dimensione mobile
*mobile size
*taille mobile

DERA PLUS

Ambiente 01

Le linee pure e squadrate della collezione Dera Plus acquisiscono un'aura di fascino e rigore in versione total black. Una composizione a doppia scrivania, ottenuta con appoggio ibrido: gamba verniciata nera libera da un lato e sistema d'appoggio su mobile di servizio dall'altro.

Uno stile moderno dove il colore pieno e scuro è reso leggero dal piano in vetro laccato e dalla gamba ad anello chiuso.

La composizione si completa abbinata alla madia Aura in finitura melaminico Rovere Gessato e gamba in metallo verniciato Nero.

The pure, square lines of the Dera Plus collection assume an aura of charm and rigour in a total black version. A double desk composition, obtained with a hybrid support: a free Nero lacquered leg on one side and a support system on a service base unit on the other. A modern style where the full, dark colour is made light by the lacquered glass top and the closed-ring leg.

The composition is completed with the Aura sideboard in a Rovere Gessato melamine finish and Nero painted metal leg.

Les lignes pures et carrées de la collection Dera Plus acquièrent une aura de charme et de rigueur dans une version totalement noire. Une composition de bureau double, obtenue grâce à un support hybride : pied libre laqué Nero d'un côté et système de support sur meuble de desserte de l'autre. Un style moderne où la couleur pleine et sombre est éclaircie par le plateau en verre laqué et le pied en anneau fermé.

La composition est complétée par le buffet Aura en mélaminé Rovere Gessato et pied en métal laqué Nero.

Scrivania con piano in vetro retrolaccato Nero e struttura nera. Mobile di servizio piccolo su zeppe laccato Nero.

Desk with Nero lacquered glass top and Nero frame. Small service base unit on Nero lacquered wedges.

Bureau avec plateau en verre laqué Nero et cadre Nero. Petit meuble de desserte sur cales laquées Nero.





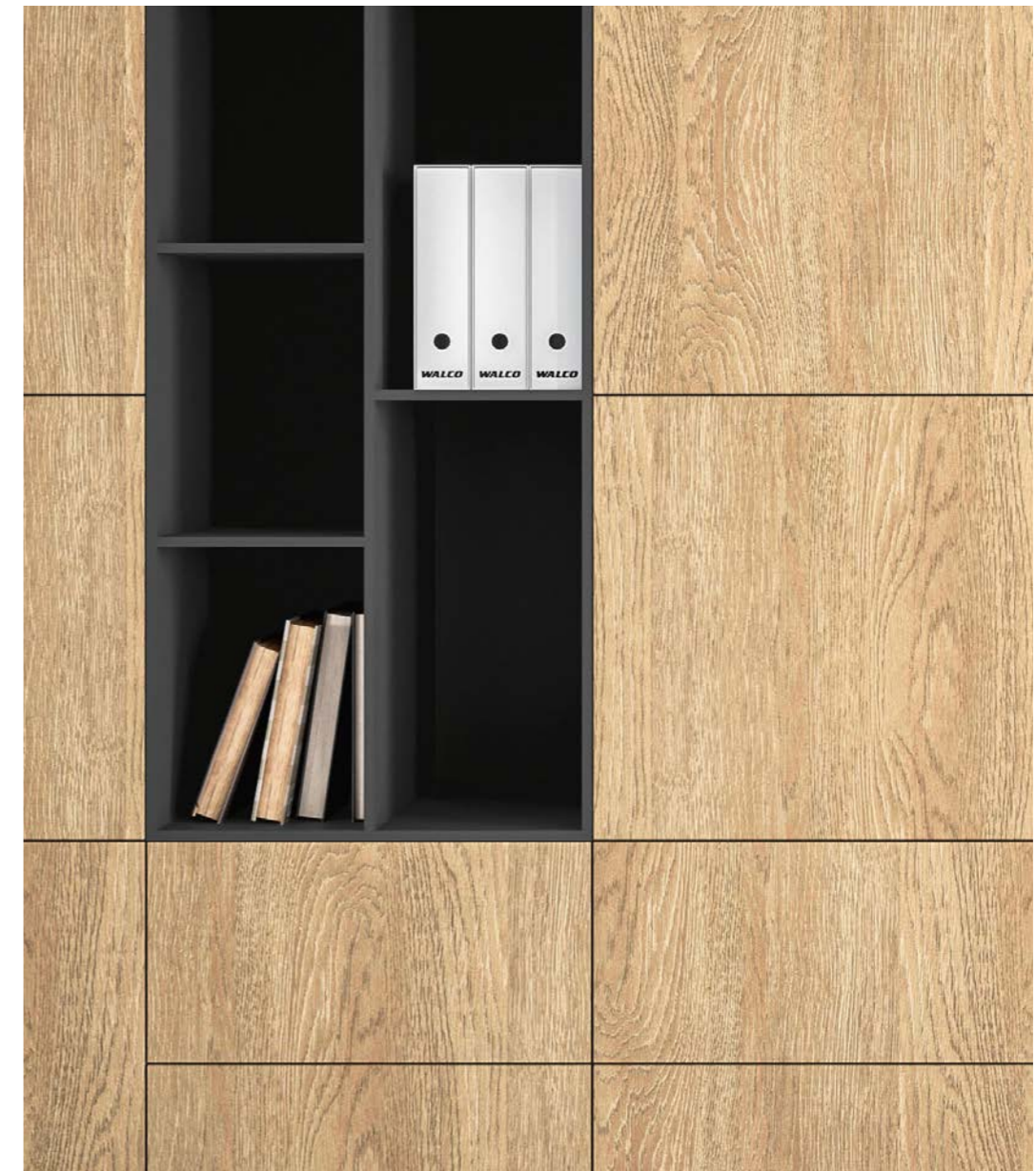

Madia Rovere Gessato con inserti laccato Nero e basamento colore Nero.

Sideboard in Rovere Gessato with Nero lacquered inserts and Nero base.

Buffet en Rovere Gessato avec inserts laqués Nero et base Nero.



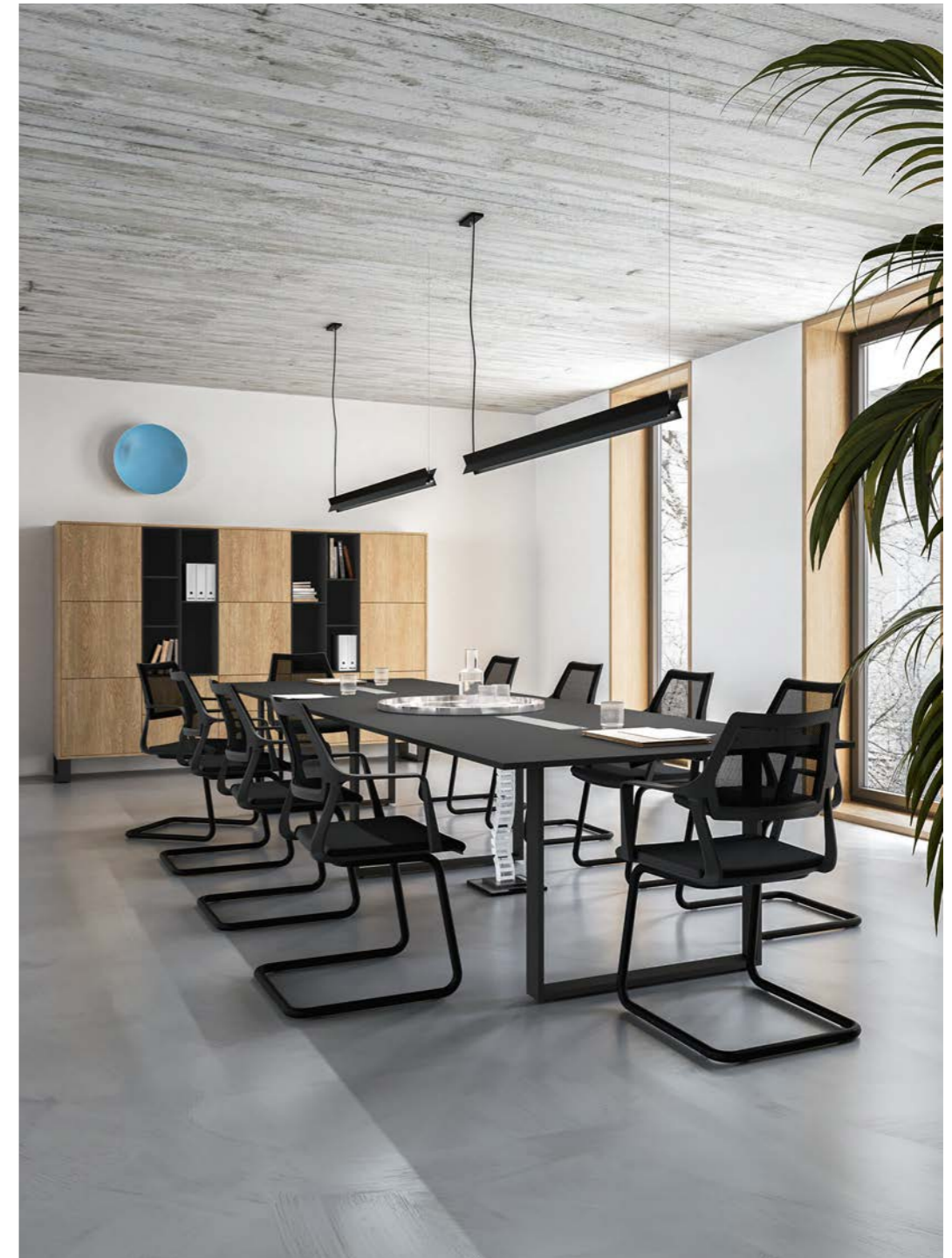

Piano tavolo riunione componibile micro rivestito soft touch opaco Black con passacavi. Struttura colore Nero.

Meeting table top modular micro coated soft touch matt Black with cable ducts. Nero frame.

Table de réunion modulable micro revêtement soft touch mat Nero avec conduit de câbles. Structure Nero.

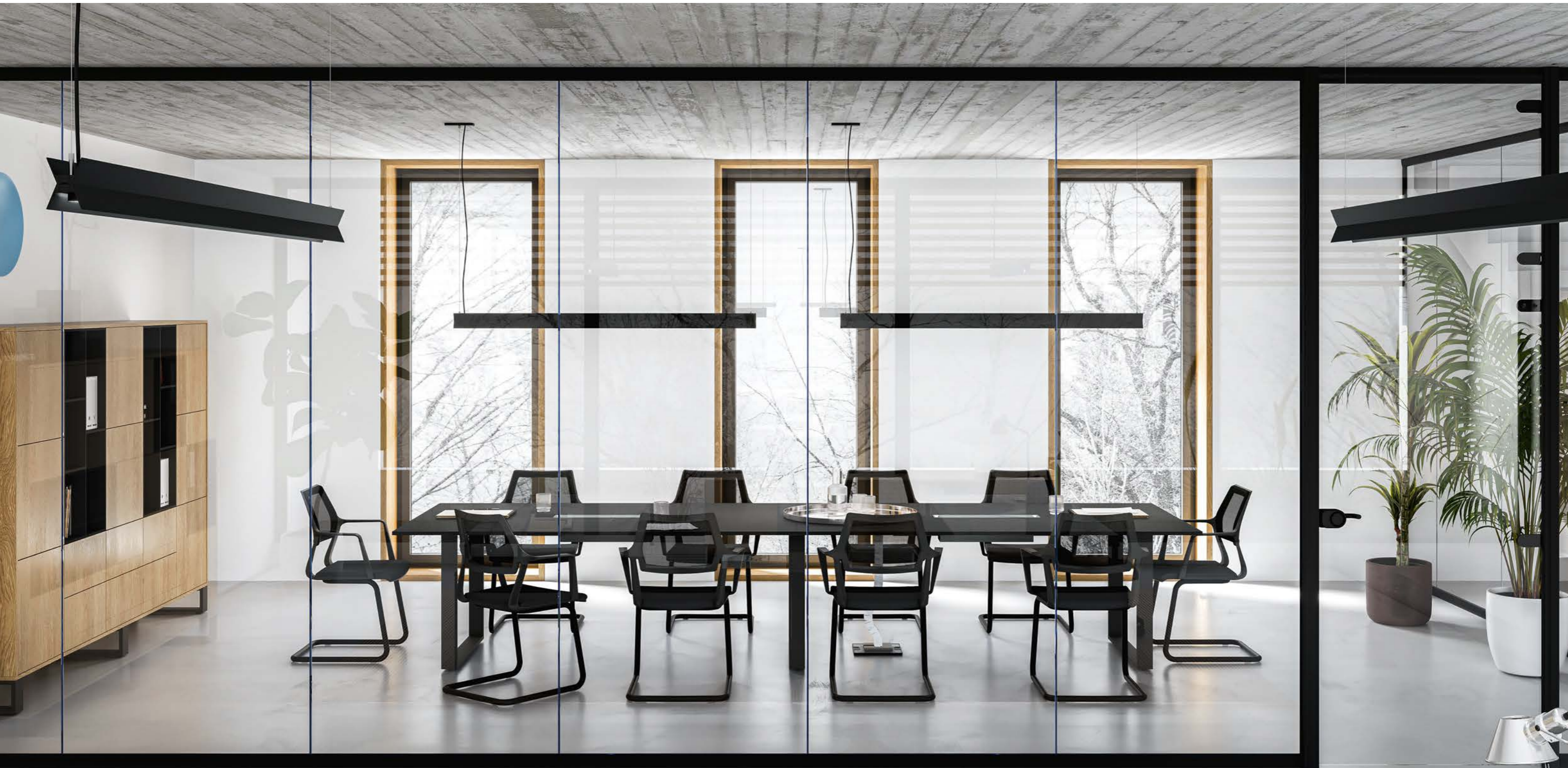

DERA PLUS

Ambiente 01

Scrivania con mobile di servizio piccolo su zeppe

Desk with small base unit on wedges
Bureau avec petit meuble desserte sur cales

Pag. 154

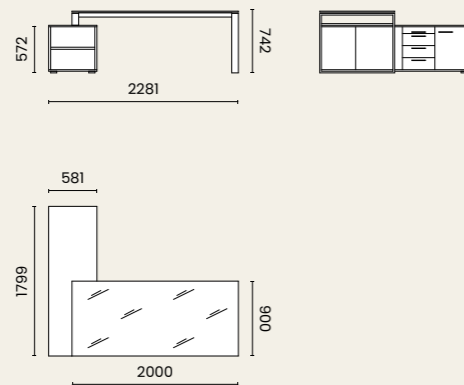

Madia Aura

Aura sideboard
Buffet Aura

Pag. 156

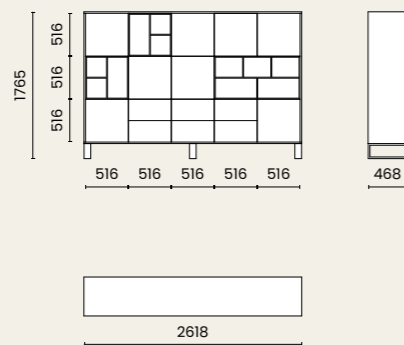

Madia Aura

Aura sideboard
Buffet Aura

Pag. 154

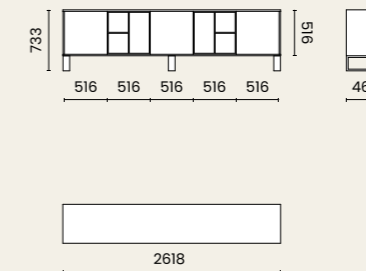

Tavolo riunione componibile

Modular meeting table
Table de réunion modulable

Pag. 161

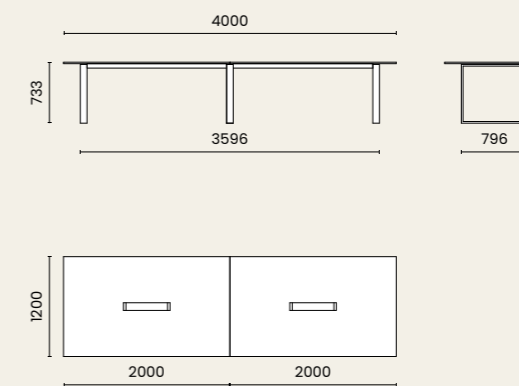

Madia Aura

Aura sideboard
Buffet Aura

Pag. 161

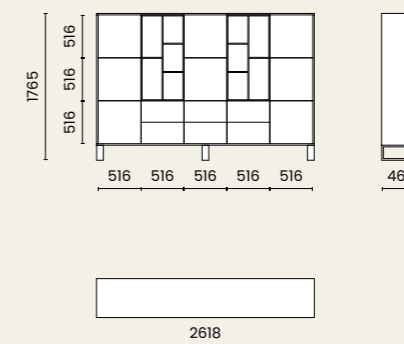

DERA PLUS

Ambiente 02

Legno e colore si incontrano per dar vita ad una composizione Dera Plus in versione creativa e fresca. L'accostamento di texture differenti, impiallacciato per il piano e gli arredi contenitori, verniciato verde per le gambe, unito all'uso del doppio colore, conferisce dinamismo e luce alla composizione, ricercata nella sua essenzialità compositiva e stilistica. La gamba in metallo con tubo 80x20 mm usata anche sulla madia Aura enfatizza il senso di leggerezza.

Wood and colour come together to provide a creative and new version of the Dera Plus composition. The combination of different textures, veneer for the top and the furniture containers, green painted for the legs, combined with the use of the double colour, gives dynamism and luminosity to the composition, studied in its stylistic and modular essentiality. The metal leg with 80x20 mm tube also used on the Aura sideboard underlines the sense of lightness.

Le bois et le coloris se rencontrent pour créer une version créative et fraîche de la composition Dera Plus. La juxtaposition de différentes textures, plaquées pour le plateau et les meubles de rangement, laquées vertes pour les pieds, associée à l'utilisation d'une double couleur, donne du dynamisme et de la lumière à la composition, recherchée dans son essentialité compositionnelle et stylistique. Le pied en métal avec un tube de 80x20 mm, également utilisé sur le buffet Aura, accentue la sensation de légèreté.



**Madia per scrivania
impiallacciato legno Rovere
Naturale con basamento
colore Verde.**

Desk sideboard in Rovere
Naturale wood veneer with
Verde base.

Buffet de bureau en placage
de bois de Rovere Naturale
avec base Verde.





Madia impiallacciato legno Rovere Naturale con inserto laccato Bianco e basamento colore Verde.

Sideboard in Rovere Naturale veneer with Bianco lacquered insert and Verde base.

Buffet en plaquage Rovere Naturale avec insert laqué Bianco et base Verde.



Scrivania, cassetiera e madie impiallacciato legno Rovere Argilla con inserto madia laccato Bianco. Struttura e basamenti colore Nero.

Desk, chest of drawers and sideboards in Rovere Argilla wood veneer with Bianco lacquered sideboard insert. Nero frame and bases.

Bureau, commode et buffet en placage de Rovere Argilla avec insert de buffet laqué Bianco. Cadre et bases de couleur Nero.







Madia impiallacciato legno Rovere Naturale con inserti laccato Bianco e basamento colore Verde.

Sideboard in Rovere Naturale veneer wood with Bianco lacquered inserts and Verde base.

Buffet en placage de Rovere Naturale avec inserts laqués Bianco et base Verde.

DERA PLUS

Ambiente 02

Scrivanìa
Desk
Bureau

Pag. 168

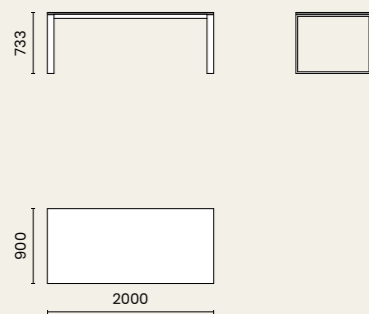

Scrivanìa
Desk
Bureau

Pag. 172

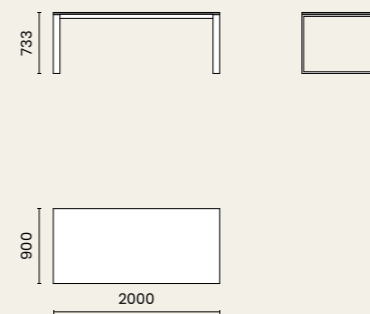

Madìa Aura
Aura sideboard
Buffet Aura

Pag. 171

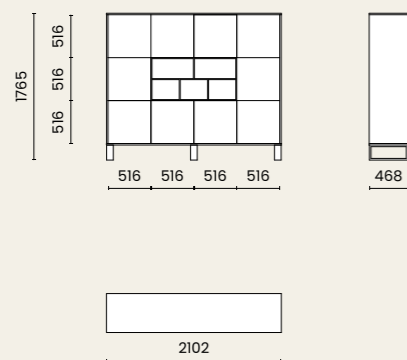

Madìa Aura
Aura sideboard
Buffet Aura

Pag. 172

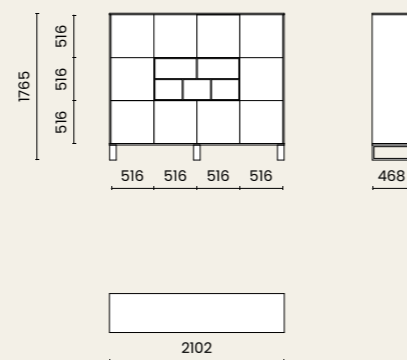

Madìa per scrivania Aura
Aura desk sideboard
Buffet de burea Aura

Pag. 168

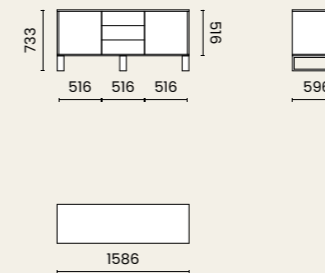

Madìa per scrivania Aura
Aura desk sideboard
Buffet de burea Aura

Pag. 172

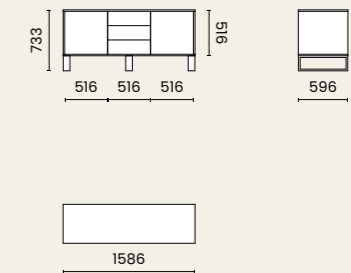

Madìa per scrivania
Desk sideboard
Buffet de bureau

Pag. 176

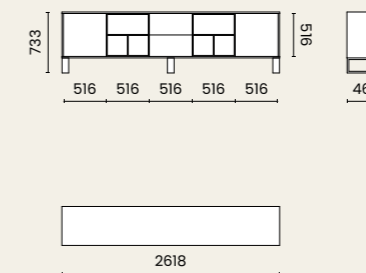

Cassettiera
Chest of drawers
Commode

Pag. 168

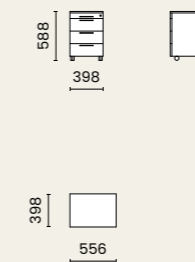

Cassettiera
Chest of drawers
Commode

Pag. 172

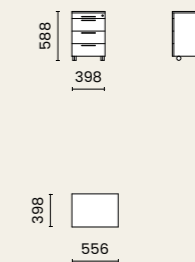

DERA PLUS

Ambiente 03

Dera Plus qui si distingue per la finitura cromata della struttura con gambe ad anello chiuso, e piedini regolabili di serie. La finitura cromata dà alla scrivania uno stile minimalista dal gusto contemporaneo. I piani possono essere in nobilitato melaminico con spessore 18 o 40 mm, e possono poggiare su mobili di servizio di grande profondità con funzione d'archivio. Il piano può essere anche in vetro temperato extrachiaro retrolaccato con spessore 12 mm.

Dera Plus is characterised by the chrome finish of the structure with closed-ring legs, and adjustable feet as standard. The chrome finish gives the desk a minimalist style with a modern touch. The tops can be made of laminated melamine with a thickness of 18 or 40 mm, and can be placed on extra-deep service furniture with an archive function. The top can also be in 12 mm thick extra-clear back-lacquered tempered glass.

Dera Plus se caractérise par une finition chromée de la structure, avec des pieds à anneau fermé et des pieds réglables en standard. La finition chromée confère au bureau un style minimaliste au goût contemporain. Les plateaux peuvent être en mélamine de 18 ou 40 mm d'épaisseur et peuvent se poser sur des meubles de desserte de grande profondeur avec fonction d'archivage. Le plateau peut également être en verre trempé rétro laqué extra clair de 12 mm d'épaisseur.



Tavolo circolare Grafite
con struttura Cromo.

Circular Table Grafite with
Chrome frame.

Table circulaire Grafite
avec structure chromée.



La serie Dera Plus è disponibile nelle versioni scrivania con mobile di servizio, scrivania indipendente e tavolo riunioni.

The Dera Plus series is available in the versions: desk with service base unit, independent desk and meeting table.

La série Dera Plus est disponible dans les versions bureau avec meuble de desserte, bureau indépendant et table de réunion.

Scrivania con piano Grafite struttura Cromo con pannelli di chiusura Rovere Rigato. Mobile di servizio piccolo su zeppe Rovere Rigato.

Desk with Grafite top, Chrome structure with Rovere Rigato end panels. Small service base unit on Rovere Rigato wedges.

Bureau avec plateau en Grafite, structure en chrome avec panneaux latéraux en Rovere Rigato. Petit meuble de desserte sur cales en Rovere Rigato.





DERA PLUS

Ambiente 03

Scrivania con mobile di servizio piccolo su zeppe
Desk with small base unit on wedges
Bureau avec petit meuble desserte sur cales

Pag. 185

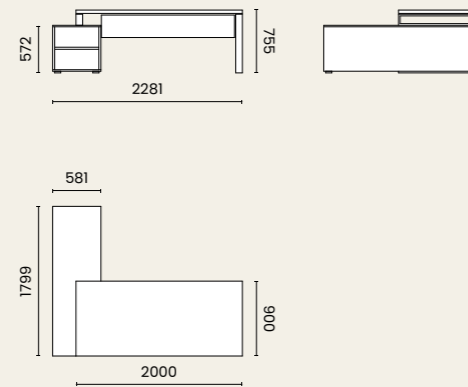

Tavolo circolare
Round table
Table ronde

Pag. 182

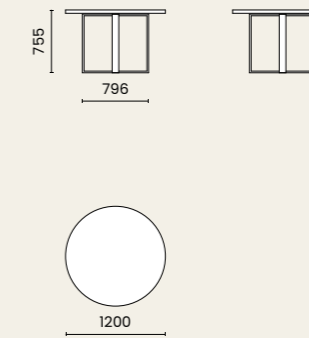

Armadio Ark
Ark wardrobe
Armoire Ark

Pag. 182

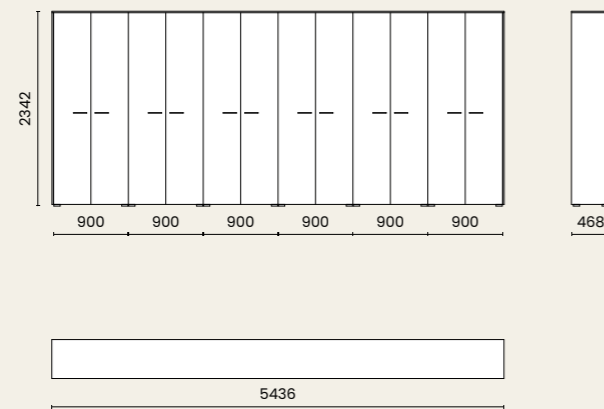

AURA

MOBILE DI SERVIZIO SCRIVANIA

SERVICE BASE UNIT DESK – MEUBLE DESSERTER BUREAU



MADIA CONTENITORE

CONTAINER CUPBOARD – PLACARD À CONTENEURS

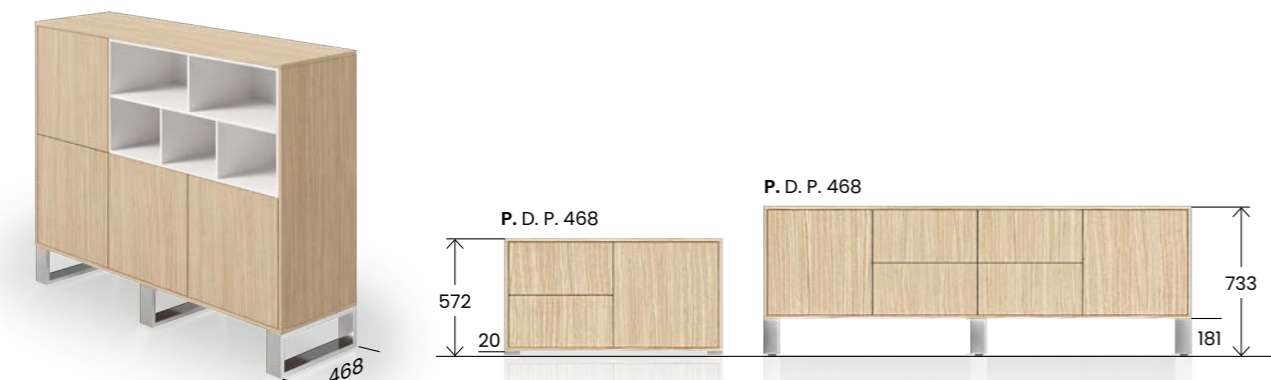

Aura è la madia contenitore disponibile in vari formati che si adatta alle esigenze e allo stile dell'ambiente in cui viene inserita. Può essere scelta con il piedino di generose dimensioni, in tubo rettangolare 80x20 mm che conferisce un senso di leggerezza e sospensione al mobile, oppure con zeppa per un effetto più minimalista e compatto. La struttura ha spessore 18 mm, è possibile scegliere tra le opzioni con solo ante e cassetti oppure abbinata a vani a giorno.

Aura is the storage sideboard available in various sizes that adapts to the needs and style of the room in which it is placed. It can be chosen with a generously sized foot in 80x20 mm rectangular tubing that gives a sense of lightness and suspension to the cabinet, or with a wedge for a more minimalist and compact effect. The structure is 18 mm thick, and it is possible to choose between options with only doors and drawers or combined with open compartments.

Aura est le buffet de rangement disponible en plusieurs dimensions qui s'adapte aux besoins et au style de la pièce dans laquelle il est placé. Peut être choisi avec le pied de dimensions généreuses, en tube rectangulaire de 80x20 mm qui donne au meuble une impression de légèreté et de suspension, ou avec une cale pour un effet plus minimaliste et compact. La structure a une épaisseur de 18 mm et il est possible de choisir entre des options avec seulement des portes et des tiroirs ou combinées avec des compartiments ouverts.

MADIA CONTENITORE

CONTAINER CUPBOARD – PLACARD À CONTENEURS



Schiena: sp. 18 mm
Scocca*: M001 Bianco + M790 Grafite
Frontali, Top, Basi
Fianchi di finitura: 24 colori nobilitati – 13 colori laccati lucidi e opachi
 5 legni impiallacciati – 4 colori micro rivestiti soft touch
Vani a giorno: 13 colori laccati lucidi e opachi
 *A richiesta con scocca laccata opaca e lucida. Ante con apertura push-pull.

Back: 18 mm thick
Body*: M001 Bianco + M790 grafite
Fronts, Tops, Bases
Finishing sides: 24 veneered colours – 13 gloss and matt lacquered colours
 5 veneered woods – 4 micro soft touch coated colours
Open compartments: 13 gloss and matt lacquered colours
 *Matt and glossy lacquered body on request. Doors with push-pull opening.

Dos : 18 mm d'épaisseur
Coque*: M001 Bianco + M790 grafite
Façades, Plateaux, bases
Côtés de finition: 24 couleurs de placage – 13 couleurs laquées brillantes et mates
 5 bois plaqués – 4 coloris avec revêtement micro soft touch
Compartiments ouverts : 13 couleurs laquées brillantes et mates
 *Coques laquées mates et brillantes sur demande. Portes à ouverture push-pull.

ARK

CONTENITORI – STORAGE UNITS – CONTENEURS



Il sistema di mobili contenitori Ark è pensato per dare la massima libertà compositiva. Sono disponibili in differenti altezze (6 con sopralzo da 768) e due larghezze. Ark può essere personalizzato anche nel colore della scocca e dei frontali. La struttura e le ante sono realizzate con spessore di 18 mm, mentre all'interno lo spessore dei ripiani è di 25 mm.

The Ark storage system is designed to give maximum compositional freedom. They are available in different heights (6 with 768 hanging unit) and two widths. Ark can also be customized in the color of the structure and the fronts. The perimeter structure and the doors are made with a thickness of 18mm, while the back measures 18mm thick and the shelves inside 25mm.

Le système de stockage Ark est conçu pour offrir une liberté de composition maximale. Ils sont disponibles en différentes hauteurs (6 avec 768 au-dessus) et deux largeurs. Ark peut également être personnalisé dans la couleur du corps et des façades. La structure périmétrique et les portes ont une épaisseur de 18 mm, tandis que le dos mesure 18 mm d'épaisseur et les étagères à l'intérieur 25 mm.

Schiena: sp. 18 mm
Scocca*: 24 colori nobilitati
Frontali: 24 colori nobilitati – 13 colori laccati lucidi e opachi – vetro fumè

***A richiesta con scocca laccata opaca e lucida. – Massima libertà compositiva. Grande resistenza. – Ante con cerniera rallentata.**

Back: th. 18 mm
Structure*: 24 melamine colours
Fronts: 24 melamine colours – 13 glossy and matt lacquered colours – Fumé glass

***On request with matt and glossy lacquered structure. – Maximum compositive freedom. Great resistance. – Doors with slow closing hinges.**

Dossier: ép. 18 mm
Structure*: 24 couleurs anoblies
Façades: 24 couleurs anoblies – 13 couleurs laquées brillantes et opaques – verre fumé

***Sur demande avec structure laquée mate et brillante. – Liberté maximale en composition. Grande résistance. – Portes avec charnière ralentie.**

ARK PLUS

CONTENITORI – STORAGE UNITS – CONTENEURS



Il sistema di mobili contenitori Ark Plus è pensato per dare la massima libertà compositiva. Sono disponibili in 5 altezze e due larghezze. La struttura perimetrale e le ante sono realizzate con spessore di 18 mm, mentre all'interno lo spessore dei ripiani è di 25 mm.

The Ark Plus storage furniture system is designed for maximum compositional freedom. They are available in five heights and two widths. The perimeter structure and doors are 18 mm thick, while inside the shelves are 25 mm thick.

Le système de meubles de rangement Ark Plus est conçu pour offrir une liberté de composition maximale. Ils sont disponibles en cinq hauteurs et deux largeurs. La structure périmétrique et les portes ont une épaisseur de 18 mm, tandis qu'à l'intérieur, les étagères ont une épaisseur de 25 mm.

Schiena: sp. 5 mm
 Scocca*: M790 Grafite
 Frontali: 24 colori nobilitati – 13 colori laccati lucidi e opachi
 5 legni impiallacciati – 4 colori micro rivestiti soft touch – vetro fumè
 *A richiesta con scocca laccata opaca e lucida. – Massima libertà compositiva.
 Grande resistenza. – Ante con cerniera rallentata.

Back: th. 5 mm
 Structure*: M790 Grafite
 Fronts: 24 melamine colours – 13 glossy and matt lacquered colours
 5 veneered woods – 4 micro soft touch coated colours – Fumé glass

*On request with matt and glossy lacquered structure. – Maximum compositive freedom
 Great resistance. – Doors with slow closing hinges.

Dossier: ép. 5 mm
 Structure*: M790 Grafite
 Façades: 24 couleurs anoblies – 13 couleurs laquées brillantes et opaques
 5 bois plaqués – 4 couleurs micro soft touch – verre fumé

*Sur demande avec structure laquée mate et brillante. – Liberté maximale en composition
 Grande résistance. – Portes avec charnière ralentie.

STEM

LIBRERIA TUBOLARE MODULARE – MODULAR TUBULAR BOOKCASE
BIBLIOTHÈQUE TUBULAIRE MODULAIRE

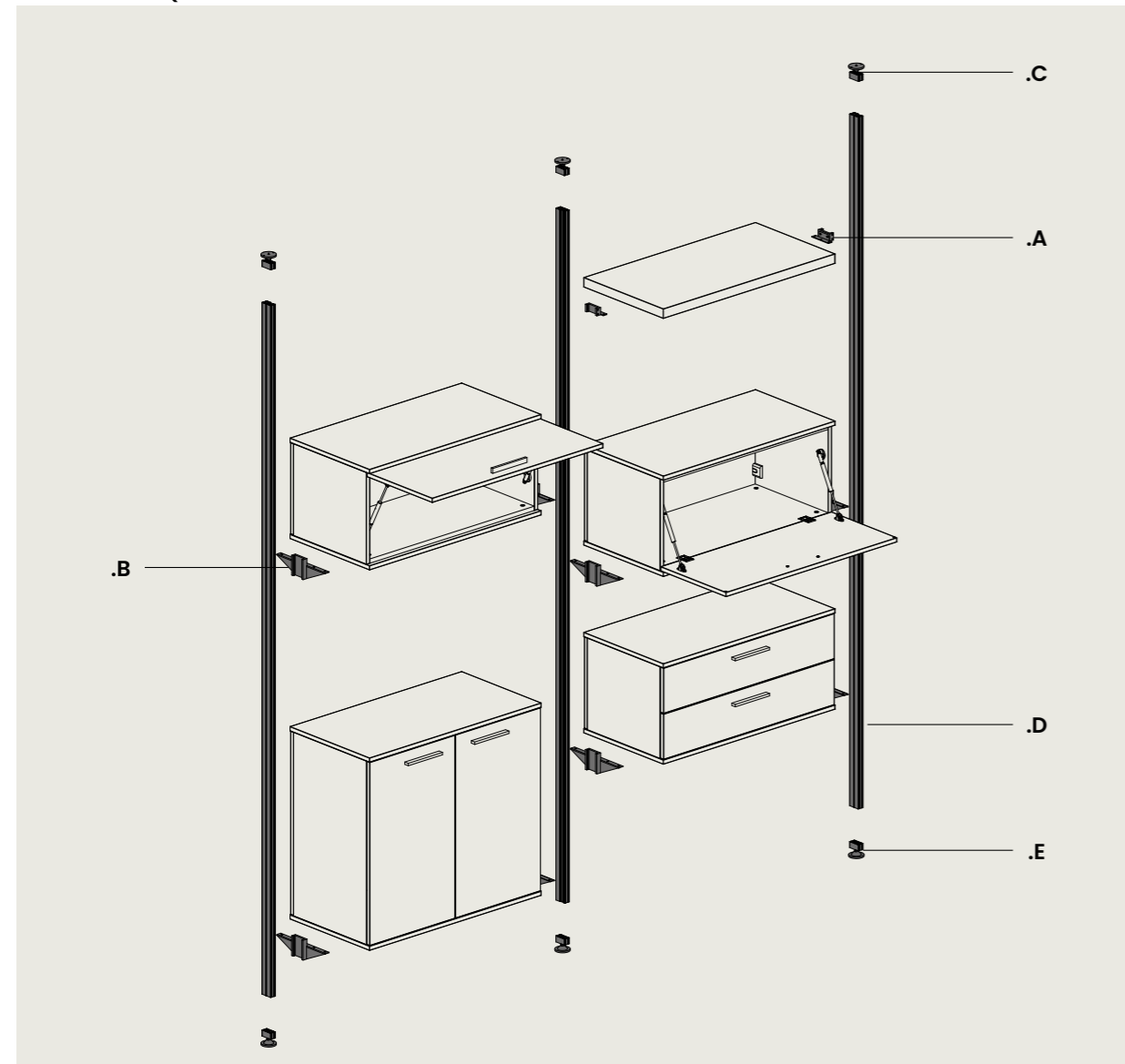

Stem è una leggerissima ed elegante libreria a soffitto, sviluppata su solidi tubolari in alluminio in finitura Metal Grey con larghezza fissa, componibile con vari elementi come mensole, contenitori a ribalta, a vasistas, contenitori ad ante e cassetti, per una personalizzazione totale della composizione. Modulare e versatile Stem può essere usata come libreria a parete o libreria bifacciale da posizionare in centro stanza, come elemento divisorio senza ostacolare la luce nell'ambiente. In più, la struttura tubolare può essere elettrificata a LED.

Stem is an extremely light and elegant ceiling-mounted bookcase, developed on solid aluminium tubing in a Metal Grey finish with a fixed width, modular with various elements such as shelves, flap, vasistas, door and drawer containers, for total customisation of the composition. Modular and versatile Stem can be used as a wall-mounted bookcase or double-sided bookcase to be positioned in the centre of the room, as a dividing element without obstructing the light in the room. In addition, the tubular structure can be electrified with LEDs.

Stem est une bibliothèque de plafond extrêmement légère et élégante, développée sur des tubes en aluminium massif dans la finition Metal Grey avec une largeur fixe, modulable avec différents éléments tels que des étagères, des abatants, des vasistas, des conteneurs de portes et de tiroirs, pour une personnalisation totale de la composition. Modulaire et polyvalent, Stem peut être utilisé comme bibliothèque murale ou double face à placer au centre de la pièce, comme élément de séparation sans obstruer la lumière de la pièce. En outre, la structure tubulaire peut être électrifiée par des LED.



Schiena: sp. 18 mm
 Scocca: 24 colori nobilitati
 Frontali: 24 colori nobilitati – 13 colori laccati lucidi e opachi
 5 legni impiallacciati – 4 colori micro rivestiti soft touch
 Mensole: Sp.40mm, 24 colori nobilitati – 13 colori laccati lucidi e opachi,
 5 legni impiallacciati
 Back: th. 18 mm
 Structure: 24 melamine colours
 Fronts: 24 melamine colours – 13 glossy and matt lacquered colours
 5 veneered woods – 4 micro soft touch coated colours
 Shelves: 40 mm thick, 24 melamine colours – 13 glossy and matt lacquered colours,
 5 wood veneers

Dossier: ép. 5 mm
 Structure: 24 couleurs anoblies
 Façades: 24 couleurs anoblies – 13 couleurs laquées brillantes et opaques
 5 bois plaqués – 4 couleurs avec revêtement micro soft touch
 Étagères: 40 mm d'épaisseur, 24 melamine colours – 13 glossy and matt lacquered colours,
 5 placages bois

STEM



.01
Mensola
 Shelf
 Étagère

L. L. L. P. D. P. Sp. Th. Ép.
 900 464 40



.02
Elemento vasistas
 Folding element
 Élément pliant

L. L. L. P. D. P. H. H. H.
 900 464 420



.03
Elemento ribalta
 Flap element
 Élément rabattable

L. L. L. P. D. P. H. H. H.
 900 464 420



.04
Elemento 2 cassetti
 2-drawer element
 Élément à 2 tiroirs

L. L. L. P. D. P. H. H. H.
 900 464 420



.05
Elemento 2 ante battenti
 2-door hinged element
 Élément à 2 portes à charnières

L. L. L. P. D. P. H. H. H.
 900 464 804



MATERIALI – MATERIALS – MATÉRIAUX

MELAMINICO TINTE UNITE – SOLID-COLOURED MELAMINE MÉLAMINE COULEUR SOLIDE



MICRO RIVESTITO SOFT TOUCH OPACO – MICRO-COATED SOFT TOUCH MATT – REVÊTEMENT MICRO MAT SOFT TOUCH



Le finiture ed i colori qui riportati devono ritenersi puramente indicativi. Per una visione realistica ed aggiornata consultare il nostro campionario colori. – Finishes and colours shown here are merely indicative. Please see our colour sample book for a more realistic and updated image. – Les finitions et les couleurs sont présentées à titre purement indicatif. Pour un rendu réel et actualisée, consulter nos échantillons de couleurs.

MELAMINICO LEGNI E MATERIALI – MELAMINE WOODS AND MATERIALS MÉLAMINE BOIS ET MATÉRIAUX

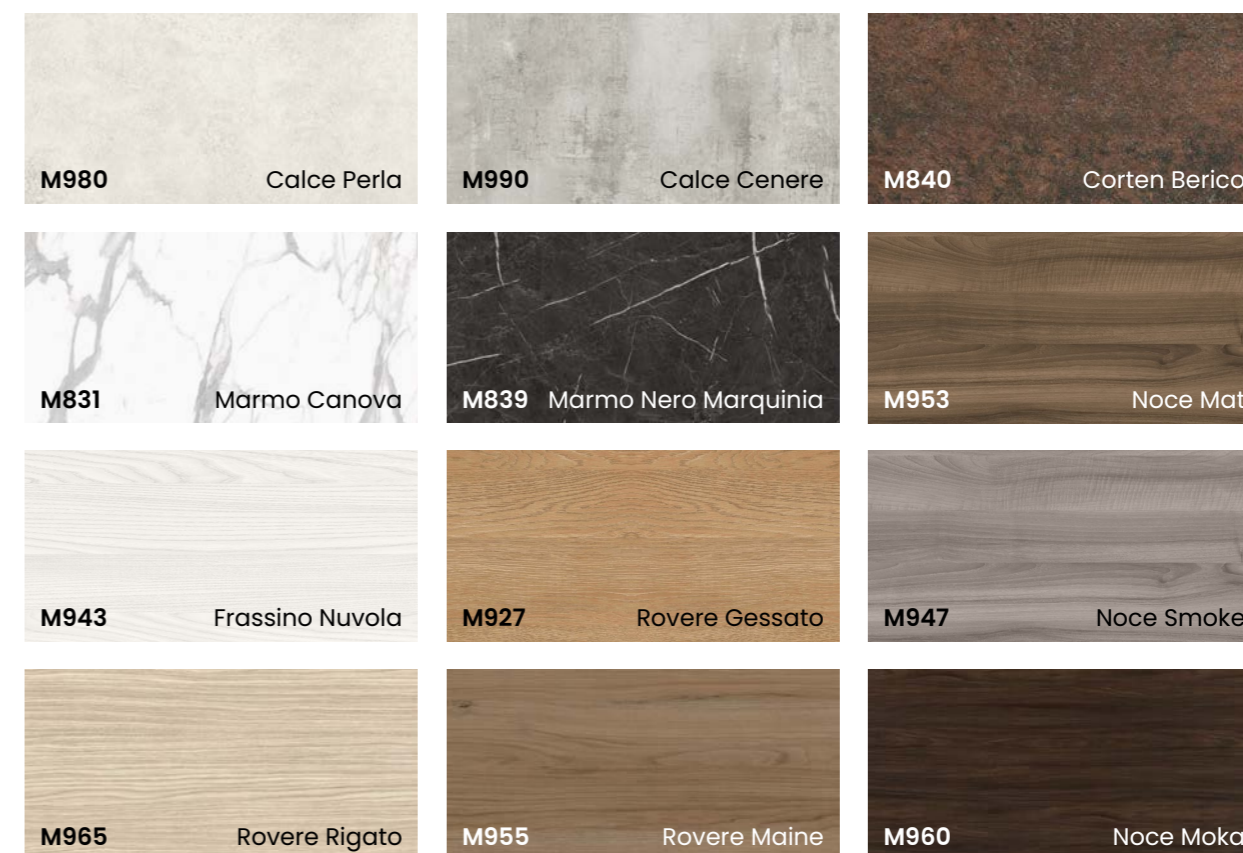

LEGNO – WOOD – BOIS

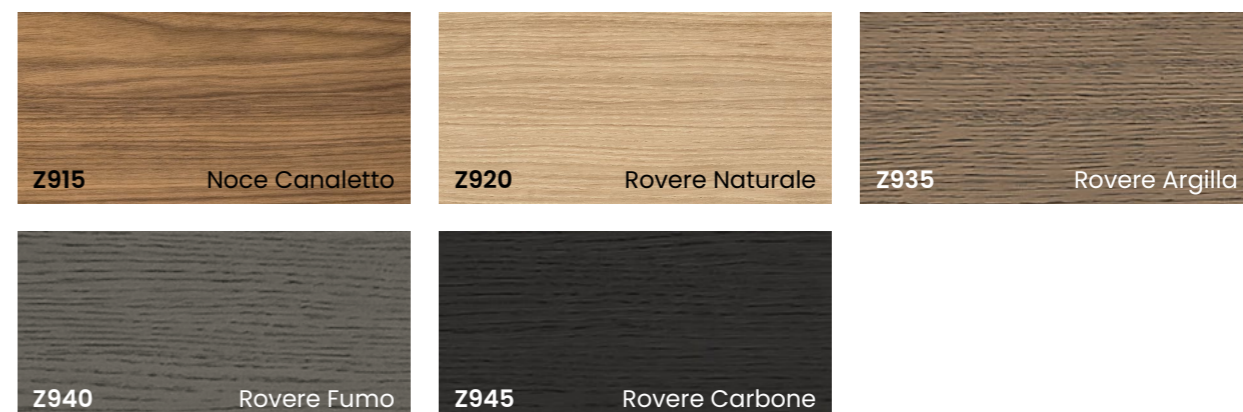

Le finiture ed i colori qui riportati devono ritenersi puramente indicativi. Per una visione realistica ed aggiornata consultare il nostro campionario colori. – Finishes and colours shown here are merely indicative. Please see our colour sample book for a more realistic and updated image. – Les finitions et les couleurs sont présentées à titre purement indicatif. Pour un rendu réel et actualisée, consulter nos échantillons de couleurs.

LACCATI GOFFRATO FINE OPACO O LUCIDO SPAZZOLATO – FINE EMBOSSED MATT OR BRUSHED GLOSSY LACQUER – LAQUE MATE GAUFRÉE OU BRILLANTE BROSSÉE



Le finiture ed i colori qui riportati devono ritenersi puramente indicativi. Per una visione realistica ed aggiornata consultare il nostro campionario colori. - Finishes and colours shown here are merely indicative. Please see our colour sample book for a more realistic and updated image. - Les finitions et les couleurs sont présentées à titre purement indicatif. Pour un rendu réel et actualisée, consulter nos échantillons de couleurs.

VETRI RETROLACCATI – BACK-PAINTED GLASSES – VERRES PEINTES AU DOS



VETRI – GLASSES – VERRES



METALLI (GAMBE) – METALS (LEGS) – MÉTAUX (JAMBES)

Kronos



Vela

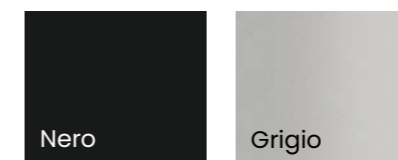

Dera



Le finiture ed i colori qui riportati devono ritenersi puramente indicativi. Per una visione realistica ed aggiornata consultare il nostro campionario colori. - Finishes and colours shown here are merely indicative. Please see our colour sample book for a more realistic and updated image. - Les finitions et les couleurs sont présentées à titre purement indicatif. Pour un rendu réel et actualisée, consulter nos échantillons de couleurs.

MANIGLIE – HANDLES – POIGNÉES

TIPO "W" in materiale plastico - made of plastic - en matière plastique



DIMENSIONI – SIZES – DIMENSIONS:
L. 174 – H. 10 – P. 22



 **RAL9006 Grigio**
grey
gris

TIPO "X" in materiale plastico - made of plastic - en matière plastique



DIMENSIONI – SIZES – DIMENSIONS:
L. 214 – H. 16 – P. 27



 **RAL9006 Grigio**
grey
gris

TIPO "E" in materiale plastico - made of plastic - en matière plastique



DIMENSIONI – SIZES – DIMENSIONS:
L. 206 – H. 29 – P. 19



 **Bianco**
white
blanc

 **Marrone**
brown
marron

 **Nero**
black
noir

TIPO "Q" in metallo - made of metal - en métal



DIMENSIONI – SIZES – DIMENSIONS:
L. 230 – H. 25 – P. 29



 **RAL9006 Grigio**
grey
gris

TIPO "C" in metallo - made of metal - en métal



DIMENSIONI – SIZES – DIMENSIONS:
L. 171 – H. 11 – P. 24



 **Cromo**
chromed
chrome

 **Bianco**
white
blanc

 **Metal Grey**

 **Satinato**
satined
satiné

 **Nero**
black
noir

TIPO "S" in alluminio - made of aluminum - en aluminium



DIMENSIONI – SIZES – DIMENSIONS:
L. 200 – H. 20 – P. 25



 **Alluminio**
aluminum
aluminium

TIPO "L" in metallo - made of metal - en métal





DIMENSIONI – SIZES – DIMENSIONS:
L. 210 – H. 18 – P. 16



 **Bianco**
white
blanc

 **Cromo**
chromed
chrome

 **Nero**
black
noir

 **Metal Grey**

*Non applicabile su contenitori con serratura - Not applicable on storage units with lock - Pas applicable sur les rangement avec serrure.

TIPO "W"



TIPO "X"



TIPO "E"



TIPO "Q"



TIPO "C"



TIPO "S"



TIPO "L"



MONTAGGIO SOLO ORIZZONTALE (escluso scorrevoli)

Nel caso di richieste personalizzate l'Azienda fornirà i frontali senza fori maniglia. La foratura dovrà essere eseguita dal cliente in cantiere.

Conseguenti errori di foratura non daranno seguito alla sostituzione dei frontali in garanzia.

HORIZONTAL ASSEMBLY ONLY (excluding sliding doors)

If specifically requested, the Company will provide fronts without handle holes. The holes must be drilled by the customer on site.

Any errors caused by drilling will not entitle the fronts to be replaced under guarantee.

MONTAGE UNIQUEMENT HORIZONTAL (exclus couissants)

En de cas de requête personnalisée, la Société fournira les façades sans trous poignées. Le perçage devra être exécuté par le propre client, sur son chantier. De conséquentes erreurs de perçage ne donneront en aucun cas droit à la substitution des façades sous garantie.

team project

rendering image
In-edito studio

styling
Lisa De Chirico

graphic design
Luca Busetto

copywriting
Serena Barabas

photolito
Luce Group

print
Luce Group

Walco spa

Via dei Cavalli, 9
31030 Cison di Valmarino (TV) - Italy
T. +39 0438 975 666
F. +39 0438 975 656
walco@walco-office.it

Export Office

Corazzin Group s.r.l.

Via Sernaglia, 52
31053 Pieve di Soligo (TV) - Italy
T. +39 0438 9099
F. +39 0438 900158
info@corazzingroup.it
www.corazzingroup.it

WALCO
OFFICE FURNITURE

www.walco-office.it

I disegni, le quote, i materiali ed i colori del presente catalogo si intendono a titolo indicativo. L'azienda si riserva di apportare delle modifiche in ogni momento senza l'obbligo di preavviso. / Drawings, dimensions, materials and colours of this catalogue are indicative only. The Company reserves the right to modify the models at any time without prior notice. / Les dessins, les dimensions, les matériaux et les couleurs de ce catalogue sont pour information seulement. Le Société e réserve le droit de modifier les modèles à tout moment et sans préavis.



WALCO
OFFICE FURNITURE